



# HDL<sup>®</sup>

## HDL<sup>®</sup>

SINCE 1985

Head office

Address: No. 24 jianzhong Road, Tianhe Development  
Zone of High&New Technology Estate, Guangzhou  
510665 China

Tel: 0086 020-85571381 Fax: 0086 020-85520532

Factory base

Address: No. 86 Lotus west Road, Lifeng Street, Shilou  
Town, Panyu District, Guangzhou  
511447 China

Tel: 0086 020-84651666 Fax: 0086 020-84860772

Email: [sales@hdlautomation.com](mailto:sales@hdlautomation.com)  
[www.hdlautomation.com](http://www.hdlautomation.com)

## BUILDING AND HOME AUTOMATION CONTROL SYSTEM

### buspro



# HDL<sup>®</sup>

## Building and Home Automation Control System

### HDL social media and more...

We, the team at HDL, are pleased to invite you to join us in the social media community. As an HDL customer, you are very important to us, and we look forward to assisting you however and whenever we can. We invite you to explore our solutions, learn more about us online, and connect with others who can inspire and help you. Follow us on Facebook, Twitter, YouTube and Google+!

### Follow us on Facebook, Twitter, Youtube and Google+!



HDLAutomation @HDLAutomation HDLAutomation HDLAutomation

## Contents

Company profile	01
Advantages of HDL	02
Global Position	03/04
Case Projects	05/10
Solutions	11/14
HDL Showroom	15/16
International Training	17
International Exhibitions	18
i-Life and iridium APP	19/20
New! HDL Buspro Wireless Products	21/33
HDL Buspro Shading Actuators	34/36
HDL Music Play Box	37/38
User Interfaces	39/65
Dimming Equipment	66/70
Relay Equipment	71/72
LED RGB Dimming Equipment	73/76
Home and Building System Equipment	77/95
Hotel System Equipment	96/104
Control System Software	105/106





## Company Profile

HDL is an international company which has prided it itself on providing the highest possible level of professional service since 1985.

With its headquarters based in Guangzhou for manufacturing, distribution and integration solutions, HDL has become one of the main participants on the international scene of home and building automation and stage lighting.

Due to the reliability of the HDL Buspro, we have developed several different kinds of projects, ranging from a smart house in Norway, through a luxury hotel in Dubai and a lighting control system in the famous Sydney Opera House, to the biggest international events, such as the Shanghai Expo 2010.

The HDL brand has been widely distributed around the world, and is available in more than eighty countries, through various dealers, integrators and distributors.

We are proud to state the reason why we have become a top company in the sector. Caring about our customers is our priority, and we are always searching for the next innovative step to provide our customers with a customised solution for their homes, and the most productive and energy-efficient solutions for their businesses.

### A powerful R&D Department

The aim of HDL is to accelerate the worldwide transition to the full automation of homes and buildings, with a full and diverse range of increasingly-affordable HDL Buspro Pro products. To this end, our engineers constantly work on the cutting edge of innovation, looking for the next challenge to create products with new functionalities, more customisable for our customers, and widely compatible with the different technologies available in the market.

### Excellent Technical Support

The best way to recognise good service is, of course, to have experienced bad service in the past, and then to experience good service to compare it against. We are confident that you will only ever experience the highest level of service with HDL. If any of your products do give you any problems, you should be able to find the solution as quickly as possible. Your time is valuable to you and us, and it should not be wasted.

Our team was designed and constructed to work closely with our R&D department. We are able to provide a fast and very direct technical support service which will help you with your installation, configuration, and all types of issues that may present themselves.

## Advantages of HDL

01

### VALUE



- Best Price-Quality / Functionality Ratio .
- Highest cost-performance in the market.

02

### SERVICE



- Fast and decisive Technical Support service.
- Customization of our products, materials or design on customers request.
- Possibility to provide OEM solutions.

03

### DELIVERY



- Quickest delivery in the market. Ready to delivery to whichever part of the world.
- Availability of shipping by plane and ship.
- Free shipping only in case of manufacturing defect.



# HDL® | GLOBAL POSITION



## ■ Europe

- Austria
- Belarus
- Belgium
- Bulgaria
- Croatia
- Cyprus
- Denmark
- Estonia
- Finland
- France
- Germany
- Greece
- Hungary
- Iceland
- Ireland
- Italy
- Latvia
- Lithuania
- Luxembourg
- Malta
- Norway
- Poland
- Portugal
- Romania
- Russia
- Serbia (Bosnia and Herzegovina)
- Slovakia
- Slovenia
- Spain
- Sweden
- Switzerland
- Czech Republic
- Netherlands
- United Kingdom
- Ukraine

## ■ Latin America & Oceania

- Antigua and Barbuda
- Argentina
- Australia
- Bahamas
- Barbados
- Belize
- Brazil
- Bolivia
- Chile
- Colombia
- Costa Rica
- Cuba
- Dominica
- Ecuador
- El Salvador
- Grenada
- Guatemala
- Guyana
- Haiti
- Honduras
- Jamaica
- Mexico
- New Zealand
- Panama
- Paraguay
- Peru
- Saint Lucia
- Saint Vincent and the Grenadines
- Sri Lanka
- Suriname
- Trinidad and Tobago
- Uruguay
- Venezuela
- Wejija La Guardia

## ■ Middle East

- Algeria
- Bahrain
- Egypt
- Iraq
- Jordan
- Kuwait
- Lebanon
- Libya
- Morocco
- Oman
- Palestine
- Qatar
- Saudi Arabia
- Sudan
- Syria
- Tunisia
- UAE

## ■ Asia

- Afghanistan
- Bangladesh
- Hong Kong
- India
- Indonesia
- Iran
- Kazakhstan
- Kyrgyzstan
- Malaysia
- Maldives
- Mongolia
- Nepal
- Pakistan
- Singapore
- South Korea
- Sri Lanka
- Thailand
- Philippines
- Turkey
- Uzbekistan
- Vietnam

## ■ Africa

- Botswana
- Central African Republic
- Congo
- Kenya
- Mozambique
- Namibia
- Nigeria and the Canary Islands
- South Africa
- Tanzania
- Uganda

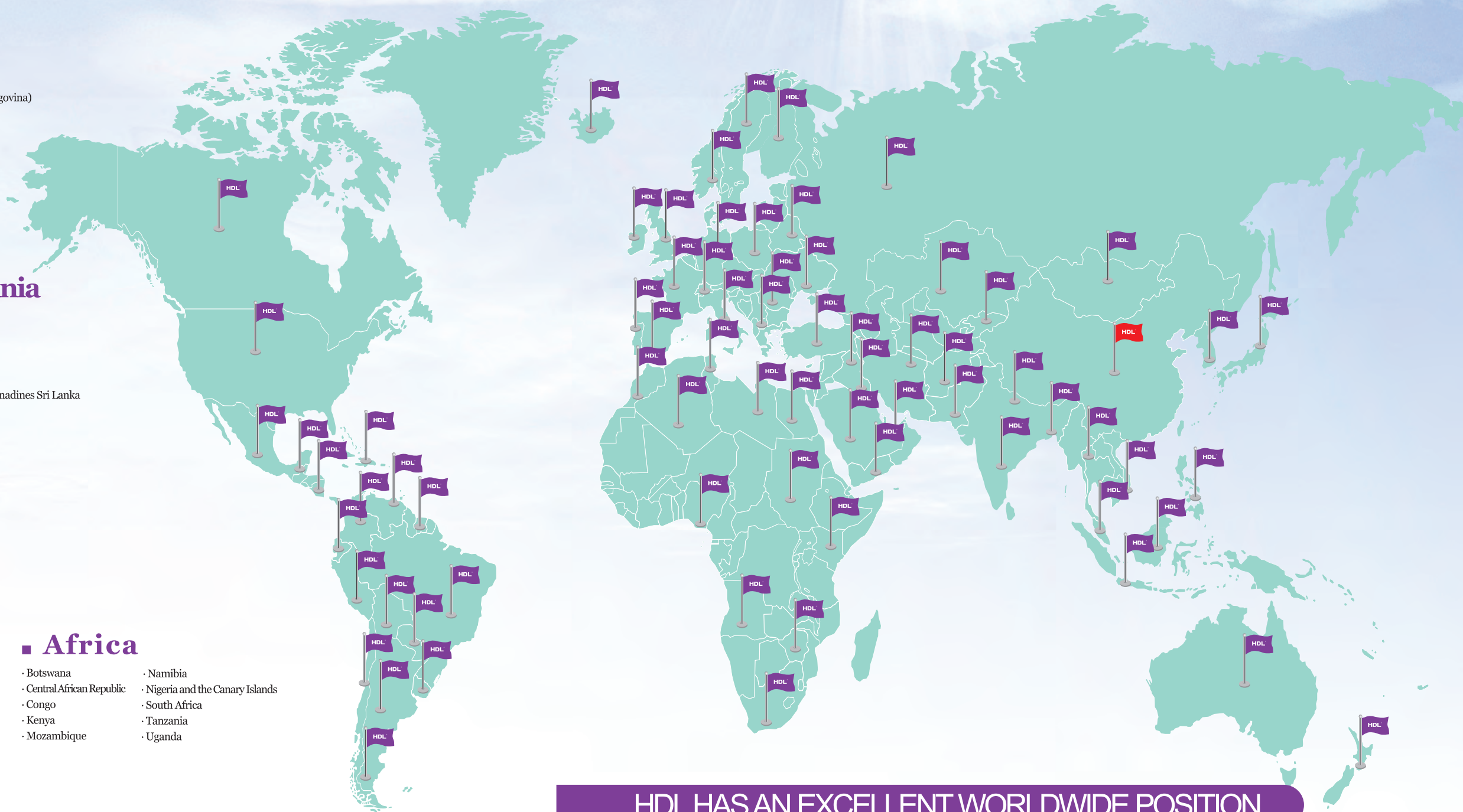

HDL HAS AN EXCELLENT WORLDWIDE POSITION

## Would you like to become an HDL Member?

■ Distributor ■ Integrator ■ Dealer ■ Installer



An interesting and promising business opportunity is waiting for you.  
Contact with us: [sales@hdlautomation.com](mailto:sales@hdlautomation.com)



- HDL is an international company with a presence in more than eighty different countries all around the world.
- Its headquarters are situated in Guangzhou, with offices in Oslo, Dubai, Munich and London.
- HDL's distribution network covers the whole world, with more than 200 dealers and distributors, and over 1,000 installation designers and electrical installers.



# BEIJING GREAT HALL OF THE PEOPLE

THEATER LIGHTING CONTROL PROJECT



# BMW WORLD MUSEUM IN GERMANY

DMX SHOW CONTROL PROJECT



## From 1995 to the present

The largest and most outstanding stage lighting control system in China was built by HDL.

HDL provided 95% of the stage lighting solution for this iconic building, which is used for legislative and ceremonial activities of the Communist Party.

From 1995 until the present, HDL has been the company in charge of maintaining, checking over and upgrading the intelligent control system, which has more than 6,000 different lighting channels, and stage lighting with more than 20,000 lamps.

The whole of the intelligent control system is managed through Ethernet, and from the control center we can monitor the state of each single device and lamp.

HDL was not only focused on the improvement of the stage lighting control system, but also enhanced and optimized the energy-saving aspect of the project.



## 2006

The BMW Museum Center is the symbol of Munich. The modern museum is located at the Olympic Park, and is a reference model for multi-functionality in building, as well as a great example of an energy-saving system.

Eventa AG, as the construction contractor, selected HDL to provide the DMX Lighting Control solution for the spectacular glass showroom.

In this case the customer asked us to keep the balance between outdoor and indoor lighting through a huge sensors system connected by HDL Buspro.





# GUANGZHOU ASIAN GAMES PROJECT

《 HOME AUTOMATION CONTROL PROJECT 》

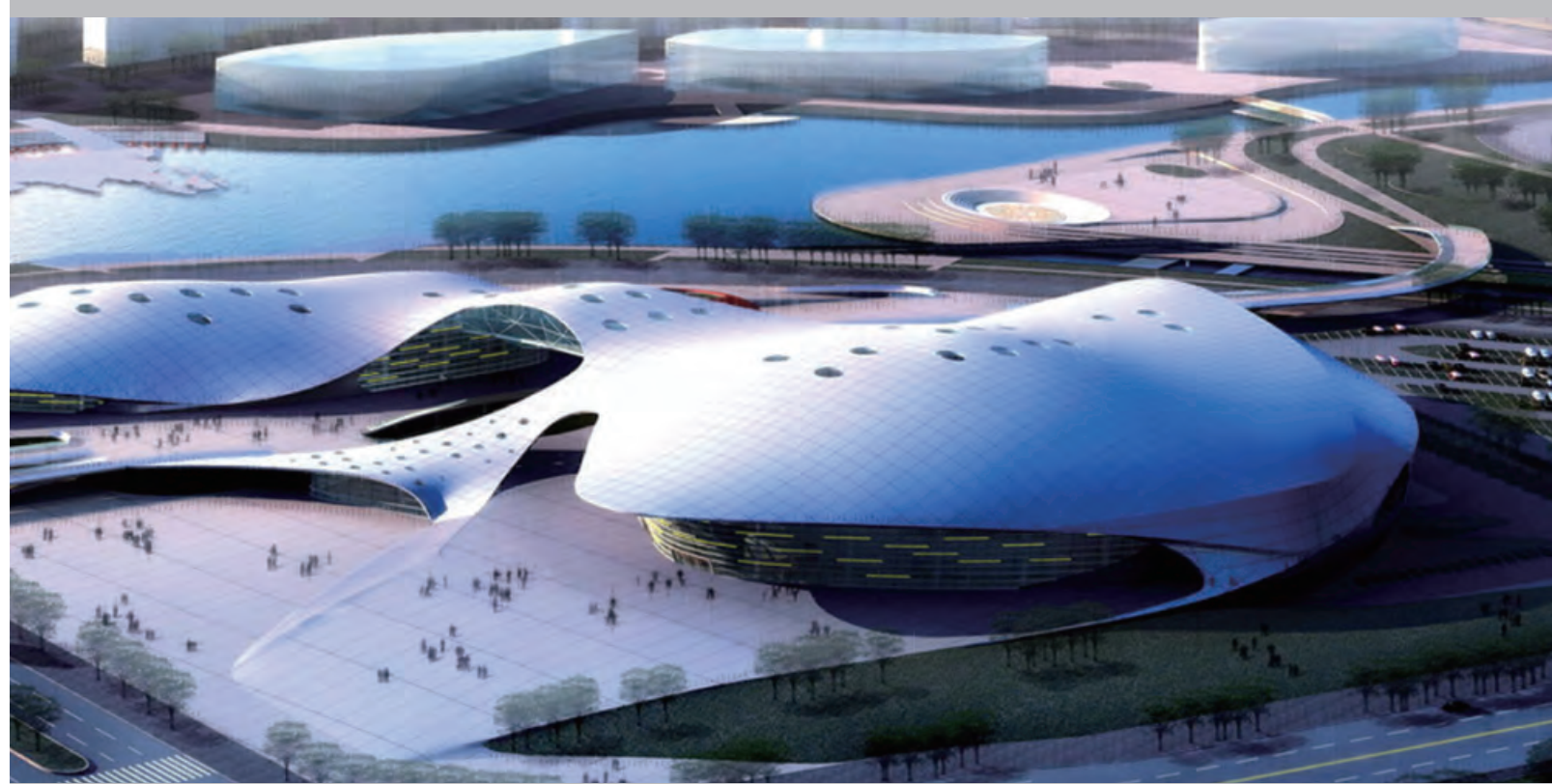

## 2010

In 2010, Guangzhou celebrated the 16<sup>th</sup> edition of the Asian Games (ASIAD), the best Asian Games so far. This was a massive event unprecedented in both size and scale. HDL contributed to this success by implementing their solutions for the Asian Games Village.

HDL provided the home automation for all the apartments in the Asian Games Villas. The solution chosen by the organization was an integration of lighting, curtains, AC, background music, video, security, monitoring systems, intercom, and door access, with everything controlled by HDL's App available for tablets and smart phones.



# SHANGHAI WORLD EXPO CENTER

《 BUILDING AUTOMATION CONTROL PROJECT 》



## 2010

Shanghai became the capital of the world during the world Expo in 2010. The theme of the exposition was "Better Life-Better City" and it had the largest number of countries participating, and was the most expensive Expo, in the history of the world, with more than 73 million participants.

HDL was the company selected to integrate the solution for the most important building in the nationalities area, the China Pavilion, and also the China Aerospace Pavilion in the cooperates area.

HDL implemented and displayed an outstanding outdoor lighting effects, controlled by a combination of lighting network systems which covers the whole area of the World Expo Park.

The company achieved the target of making unique buildings which captured the attention and imagination of all the visitors, and HDL became established as an expert and reliable company for urban outdoor lighting landscapes, and stages for massive events.





# VIETNAM GRAN HO TRAM STRIP CASINO HOTEL

《 LUXURY CASINO HOTEL AUTOMATION PROJECT 》

# SOFITEL CASABLANCA TOUR HOTEL

《 LUXURY RESORT HOTEL AUTOMATION PROJECT 》



## 2013

HDL's Hotel Guestroom System was implemented in all of the 541 guest rooms in the hotel, in the biggest resort in Vietnam. This included: integrating lights control and AC control; clean room notifiers; provision of room status to reception (mostly used to prepare services in advance); motion sensors; dry contact modules for integration with doors' magnetic sensors; and door bells with DND service (Do not Disturb showed at the door's bell display).

The big challenge for HDL was to satisfy the requirement from the customer to make HDL's Hotel System compatible with the software used for the general management of the hotel, a hospitality ERP from the USA. Our engineers started to work right away, and HDL achieved the target with a high score. The customisation for the client was highly successful, and ready on time.

Furthermore, when the guest is checking in or out, the reception staff can remotely control all the room's functionalities from reception in order to prepare the room for a warm welcome to the customer in the case of check-in, or to save energy by switching off all the lights in the room after the customer has checked out.

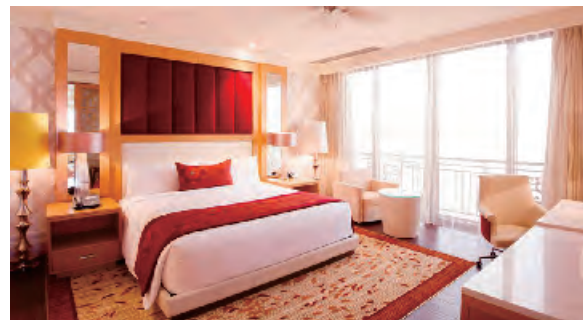

## 2013

All 171 rooms and 30 suites of the SOFITEL Casablanca had lighting, AC, and curtains fully automated, with control enabled via a customized DLP panel. To enable the energy consumption and guestroom amenities to be controlled and monitored, the hotel was equipped with HDL guestroom management software.

The solutions that you can find in the rooms are a control panel inside the room from which the customer can display the room status on an external doorbell display; and lighting and curtain functions that can be controlled from within the room from the room controller designed by HDL.

The system brought a minimalist and elegant but homely style to both customers and hotel workers. Different scene modes such as Read Mode and Night Mode make the otherwise complicated on/off easier and more attractive for the guests.

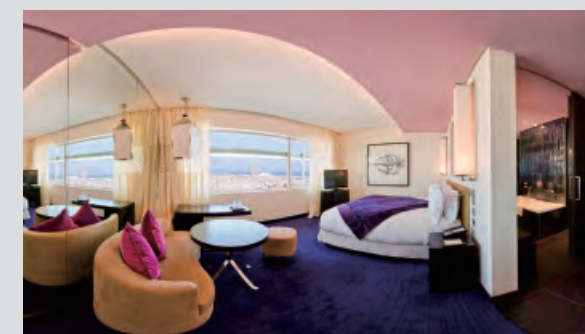



# INTELLIGENT LIGHTING SOLUTIONS

# SMART PRESENTATION SOLUTIONS

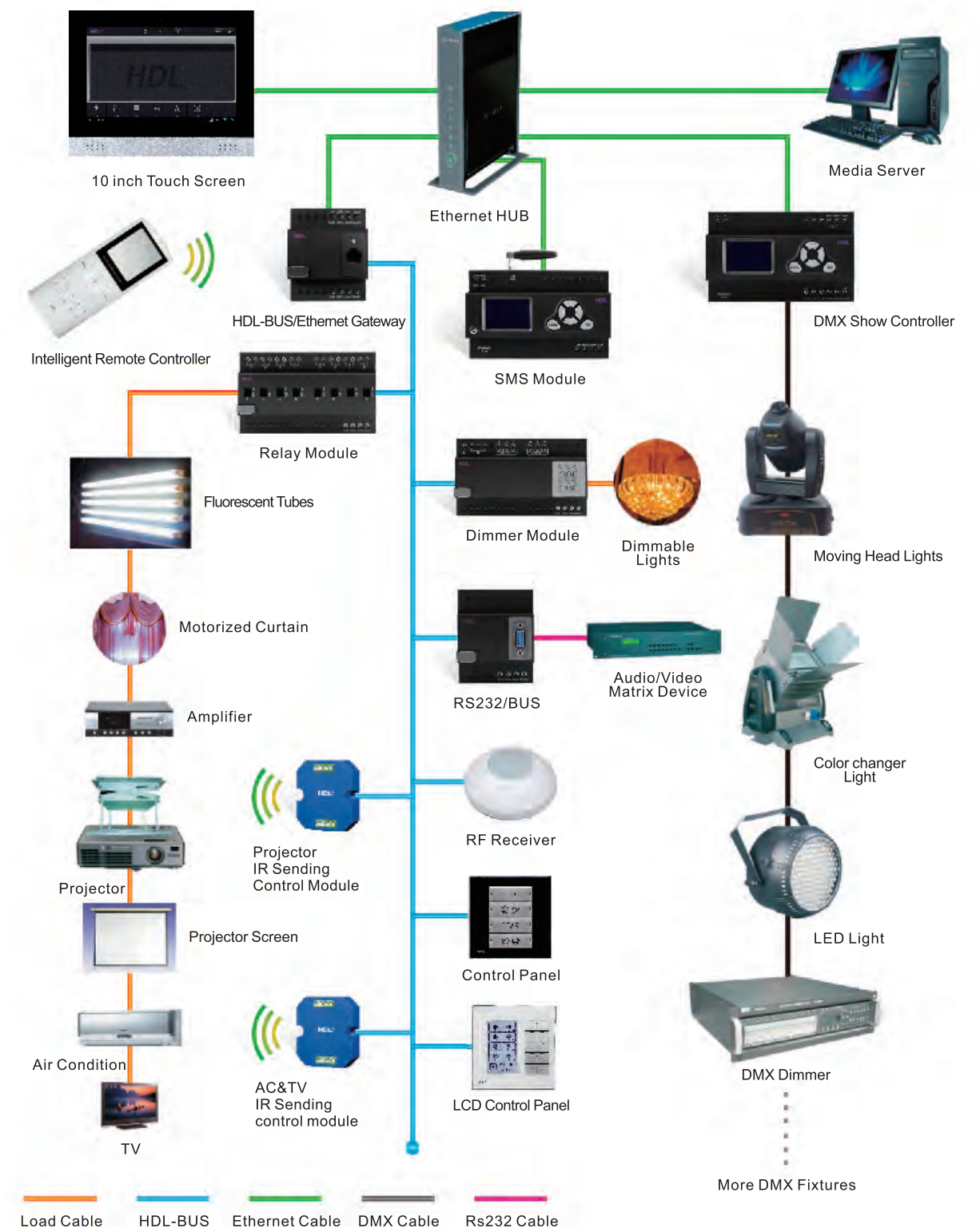
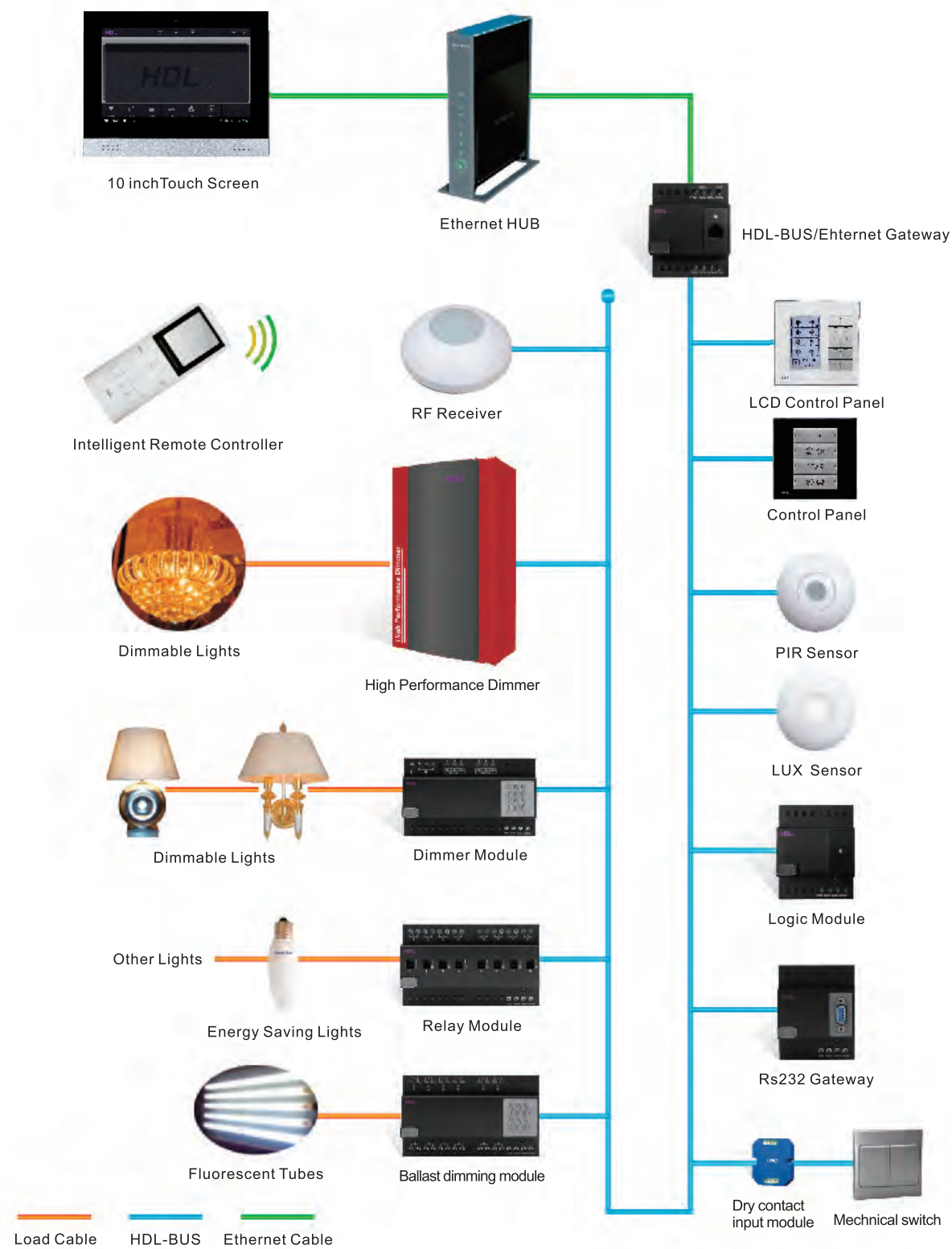



# SMART HOME SOLUTIONS

# SMART HOTEL SOLUTIONS

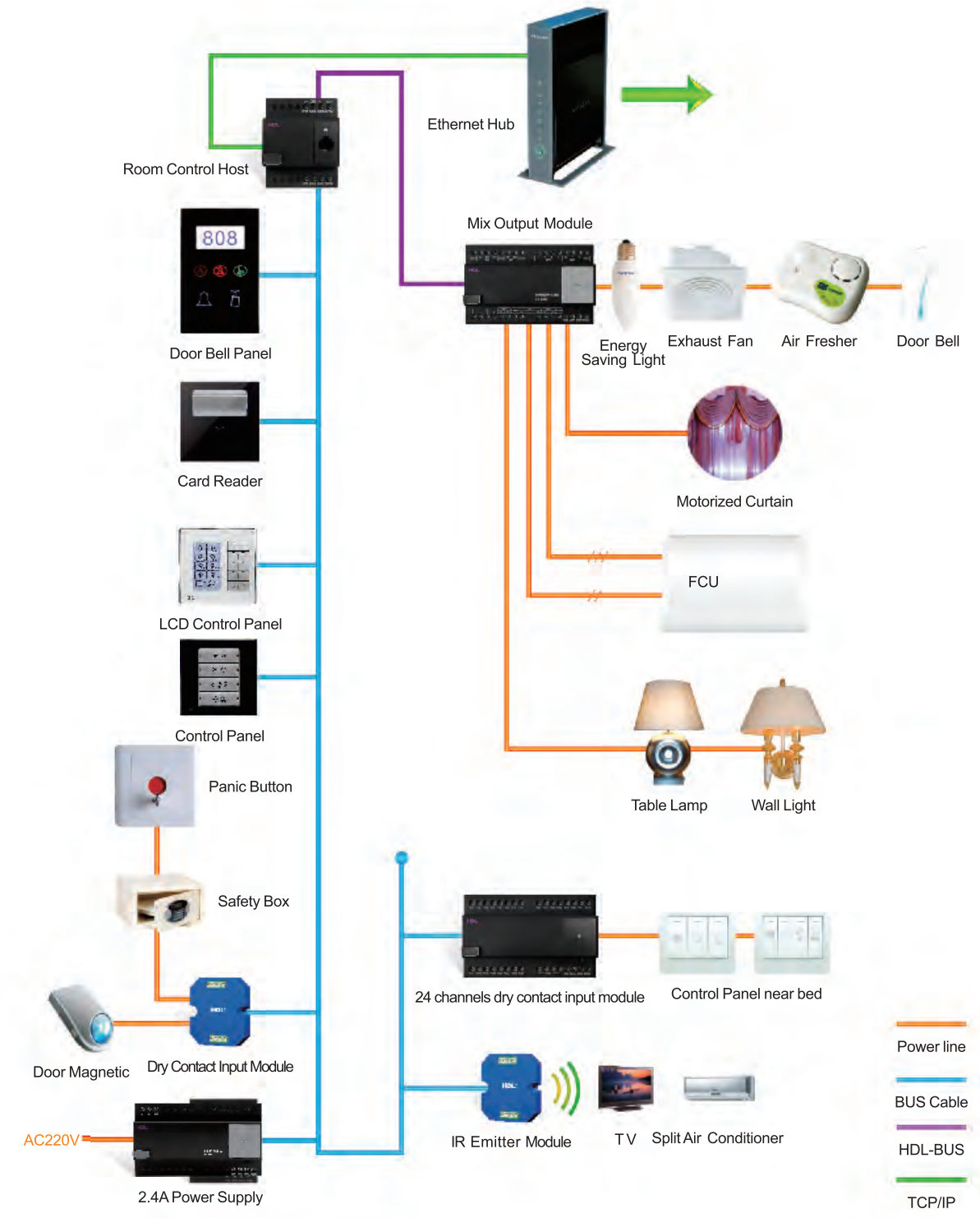
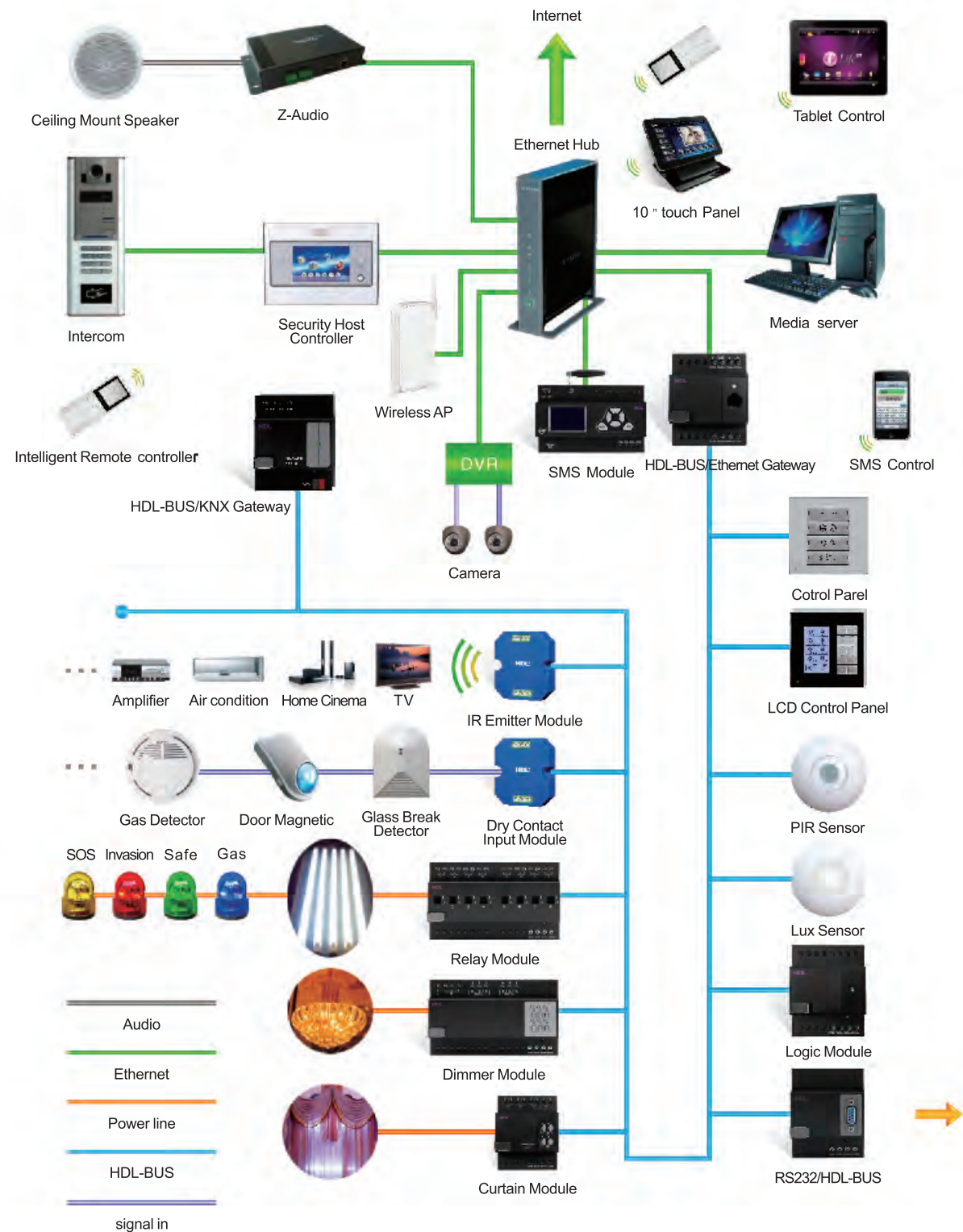





## WELCOME TO HDL'S SHOWROOM

In HDL we think the best way to showcase our products is to allow you to experience them as if they were in your own home. We do this in our comfortable showroom which is situated in Guangzhou, China.

All our guests will feel and test the HDL Buspro technology in all the corners of this smart house, which you are cordially invited to visit, to experience the exciting home automation in its pure state.

“Designed to stimulate your ideas and be a source of inspiration”



“Take a closer look to see how home automation equals comfort and luxury”

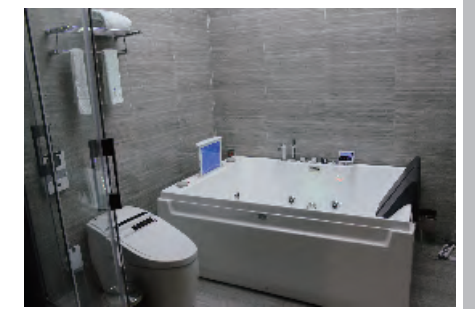

“The HDL Buspro training sessions and celebrations take place in the multi-functional auditorium room”



“Feel how different scenes can create different environments and moods in your home.”

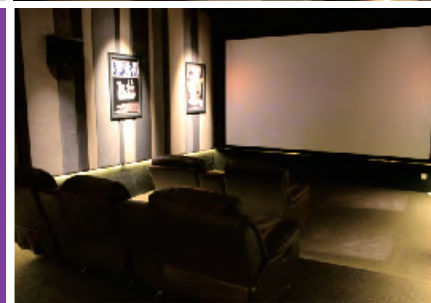

“We are eagerly looking forward to your visit. We would love to have you as our special guest!”

“We display useful innovative features, helping you to identify a design with functional benefits to suit your own needs.”

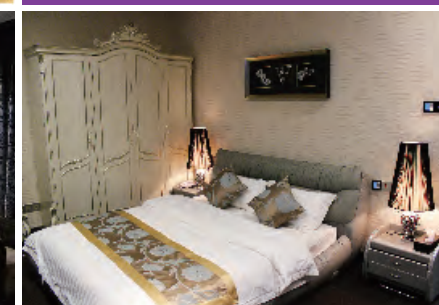



## INTERNATIONAL TRAINING FOR HDL Buspro

Join the International HDL Buspro training and get the official HDL high-skilled user certification.

Also visit our factory and learn how the products are created, and how quality control is performed; because the best way to know how HDL Buspro works is to learn it from the engineers who have created it.

### Characteristics of the HDL Buspro training

- Every year we arrange three or four international training sessions.
- The training sessions are delivered through fluent English.
- Different levels: basic course and advanced course.
- HDL provides special training for repair parts.
- HDL helps you to arrange all that you need for your trip.
- HDL also provides training in other countries: ask your distributor for details.

## INTERNATIONAL EXHIBITIONS

HDL attends different theme exhibitions and fairs. HDL's attractive booth displays different solutions tailored to show the most relevant aspects of HDL Buspro to suit the topic of the specific event, to catch the attention of the new customers who still don't know about HDL Buspro

### HDL is always present at the most important events and exhibitions



### International exhibitions in which HDL has been presented

#### Frankfurt Light Building Expo

March 2014 in Frankfurt, Germany  
Lighting and Building



#### Intersec 2015

January 2015 in Dubai, UAE  
The Region's Annual Safety, Security & Fire Protection



#### ISE 2015

February 2015 in Amsterdam, Netherlands  
Integrated Systems Europe



#### YAPI-TURKEYBUILD Istanbul

April 2015 in Istanbul, Turkey  
Building, Construction Materials and Technologies

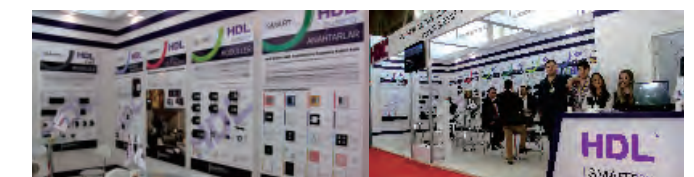

#### Grand Designs Live 2015

May 2015 in London, UK  
Consumers Electronics and Home Automation

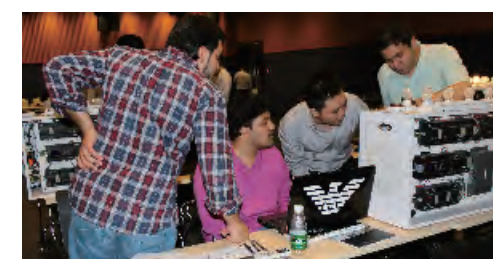





## Control everything from everywhere

CONTROL ALL THE FUNCTIONS OF HDL Buspro FROM YOUR SMARTPHONE AND TABLET

i-Life App

Systems Supported: iOS + Android



## Universal Visualization & Control Software

CONTROL SOFTWARE FOR HDL Buspro

Powered by iRidium mobile

Systems Supported: iOS + Android + OSX + Windows 8



“Control your entire home automation system and audio/video equipment from a user-friendly interface”



1 Install iRidium Transfer and iRidium GUI Editor on your computer



2 Setup the iRidium App on your control device

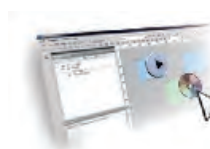

3 Create your interface or adjust a ready GUI template using iRidium GUI Editor



4 Upload your interface onto the target device using iRidium Transfer

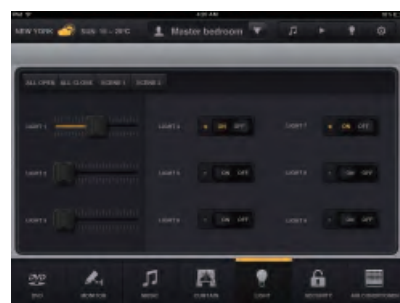

• Lighting



Lighting



• DVD



Blind



Climate



Floor Heating



Background Music



Security



Multi Media



Ventilation



Irrigation



And More...



• Curtain

## Description

Nowadays, consumers look for comfort and simplicity. This concept, extended into the home and building automation field, means the ability to have full control of HDL Buspro functions from the everyday devices that everybody has always on hand, like the smartphone or tablet.

i-Life is an app developed by HDL's engineers specially for HDL Buspro. With an attractive design and user-friendly interface, it is perfect for all kinds of people, whether or not they are familiar with the technology. Everybody will enjoy the power of controlling all the functionalities within their house or business with the flick of just a few buttons.



Metro interface



Neon interface



V2.1



Black Interface

• HDL Buspro

• KNX

• Crestron

• AMX

• Modbus

• Teco

• iNELS

• Helvar

• Domintell

• Lutron

• Any Audio/Video equipment and Media Server





## Wireless Intelligent Switch EU

MPL8-RF.18

### Parameters

- Power supply: DC5V (from wireless power interface)
- Power consumption: 55mA/DC5V
- Wireless transmit power: +10dbm
- Wireless receive sensitivity: -90dbm
- Installation : Wall mounting
- Dimensions: 86×86×10.5(mm)

### Functions

- Built-in temperature sensor.
- Specified pages for AC, floor heating, music, etc.
- Multi key mode: Single on-off, Single on, Single off, Combination on-off, Combination on, Combination off, Double click/single switch , Double click/combination switch, Momentary, Clock, Short/Long press, Short Press/Long jog.
- Multi key control modes: Scene, Sequence, Timer switch, Universal switch, Single channel lighting control, Broadcast scene, Broadcast channel, Curtain switch, GPRS control, Panel control, Security module, Z-audio control
- Supports online upgrading.

MPL8-RF.18

NEW PRODUCT

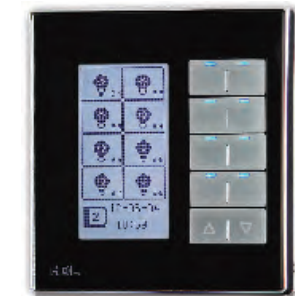

- Control more than 3000 targets
- 147 Languages
- Link to different pages
- Easy Programming

The HDL-MPL8-RF is a wireless panel which is able to work in conjunction with the wireless power interface. Featuring an improved and customizable LCD display, the HDL-MPL8-RF enables users to find information effortlessly.

### Electronic icons

The new HDL-MPL8-RF has an improved LCD screen that is capable of displaying multiple icons, which can then be customized via an extensive updatable icon library. Messages, device status, and percentage information can all be displayed, enabling a user to find information effortlessly.

buspro  
WIRELESS

NEW PRODUCT

Utilizing a wireless mesh IEEE 802.15.4 communication network, the HDL wireless panel range can be installed anywhere in a building without needing a physical connection to the Buspro mainframe. Using frequencies of 768, 868, and 900 MHz, the connection can fulfill the long distance communication frequency standard applying in different countries; which ensures efficient and precise data transmission.

### All in one

In a single HDL-MPL8-RF panel there are seven different pages dedicated to the control of common automation systems. The following systems are included, four pages dedicated to lighting, one page dedicated to HVAC, one page for floor heating, and one page for background music. Each page can hold multiple targets enabling the user to take complete control over all aspects of their automation solutions, with one unifying HDL-MPL8-RF panel.

### Customizable

The HDL-MPL8-RF panel is completely customizable, and has an extensive range of fascia colours, and materials available. This tailoring even extends to the LED button status indicators which have adjustable light intensity levels. The module can also be incorporated into a double panel installation, or can be flush mounted. These customization options allow a user to have their exact requirements not only met, but exceeded.



White Glass Blue Glass Pink Glass Orange Glass



Lighting Security Lighting



Curtains Air Conditioning Floor Heating Background Music



## Wireless Touch Button Switch EU

MPT4-RF.18

NEW PRODUCT

MPT4-RF.18

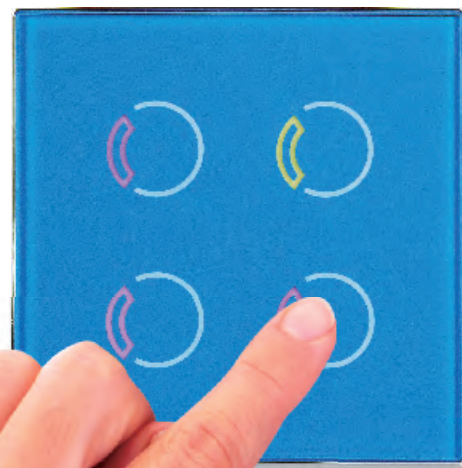

### Parameters

• Power supply: DC5V (from wireless power interface)
• Power consumption: 45mA/DC5V
• Wireless transmit power: +10dbm
• Wireless receive sensitivity: -90dbm
• Installation : Wall mounting
• Dimensions: 86×86×10.5(mm)

### Functions

• Multi Key Mode: Single on, Single off, Single on/off, Combination on, Combination off, Combination on/off, dblclick/single switch, dblclick/Combination switch, Momentary, Short/Long Press, Short Press/Long Jog.
• Multi Key control Type: Scene, Sequence, Timer switch, Universal switch, Single channel lighting control, Curtain switch, GPRS control, Panel control, Broadcast control, Broadcast channel, Security module, Z-audio control
• Adjustable backlight color and intensity
• Supports online upgrading

### RGB LED backlight

Each button is illuminated by an RGB LED back light which can change colour or intensity when used for different applications, based on the preference of the user. This customisable button back light ensures that the unit can blend into any situation or environment.

### The color, icons and pattern of the plate can be customised



### Based on your personal favorites or your requirements

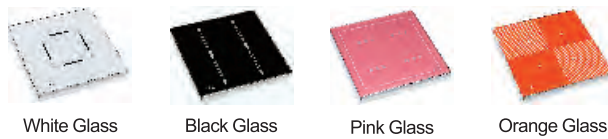

White Glass Black Glass Pink Glass Orange Glass

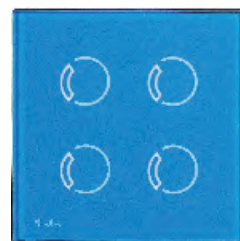

Status without backlight color

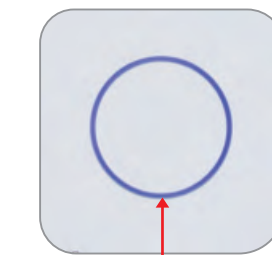

All RGB color are selectable

## Wireless Intelligent Switch EU

MP04R-RF.18

NEW PRODUCT

MP04R-RF.18

The HDL-MP04R-RF wireless panel has a seamless glass finish, and a backing plate specifically designed based on European standard. The module can control multiple targets via its distinguished buttons, which have a customizable RGB LED back light.

### Parameters

• Power supply: DC5V (from wireless power interface)
• Power consumption: 45mA/DC5V
• Wireless transmit power: +10dbm
• Wireless receive sensitivity: -90dbm
• Installation : Wall mounting
• Dimensions: 86×86×10.5(mm)

### Functions

• Multi Key Modes: Single on, Single off, Single on/off, Combination on, Combination off, Combination on/off, double click/single switch, double click/Combination switch, Momentary, Short/Long Press, Short Press/Long Jog.
• Multi Key control Types: Scene, Sequence, Timer switch, Universal switch, Single channel lighting control, Curtain switch, GPRS control, Panel control, Broadcast control, Broadcast channel, Security module, Z-audio control
• Adjustable backlight color and intensity



### Two custom color status per button



RGB Values



Each button is illuminated by a RGB LED back light which can change colour or intensity when used for different applications, based on the preference of the user.

### Background

Switchers are elements very important when you design a new space. That's why we want to give the possibility to customize the plate and frame to find the style which suits you best

### Customize different plate and frame color



Pink Glass Blue Glass White Glass golden Glass

### Buttons

Small details are important because they give a distinguished touch of luxury and fashion to your home and business. To feel identified with these values, you can change the button's ring colors to adjust it with your house style or your color business.

### Choose the style of the buttons



Bronze Aluminum Aluminum+Bronze



## 8 Buttons Switch EU

MP8B-RF.18



The HDL MP(4/6/8)-RF wireless panel has large dual control buttons, which can be customized by the end user. There are 4-8 button combinations available, with each button having LED status indicators that can show which function is currently being used.

### DIY customization

The HDL MP(2/4/6/8)-RF series offers users the ability to replace the button names or icons, by simply removing the plastic sleeve and placing one of their own designs under it. This enables rapid changes without the need for computers, engraving, or etching. As long as a user has access to a piece of paper, and a pen or pencil, the customization can be accomplished. Coupled with this, a range of fascia are available, make the unit suitable for any environment or situation.

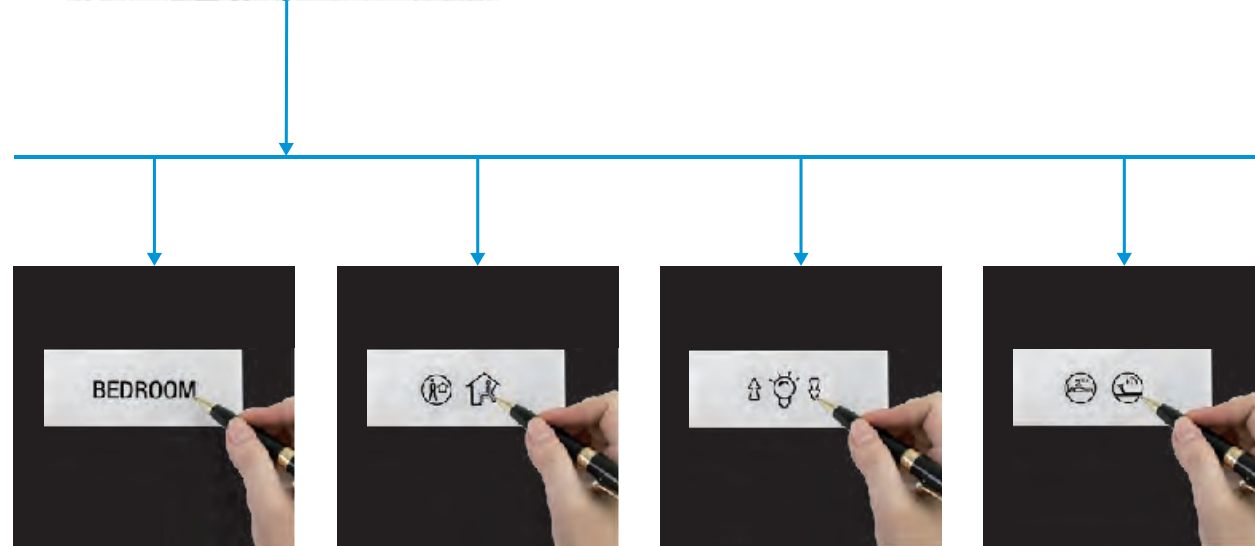

## 2/4/6 Buttons Switch EU

MP2B-RF.18 / MP4B-RF.18 / MP6B-RF.18

### Parameters

- Power supply: DC5V (from wireless power interface)
- Power consumption: 57mA/DC5V
- Wireless transmit power: +10dbm
- Wireless receive sensitivity: -90dbm
- Installation : Wall mounting
- Dimensions: 86×86×10.5(mm)

### Functions

- Key Mode: Single on/off, Single on, Single off, Combination on, Combination off, Combination on/off, Double click single on/off, Double click combination on/off, Inching, Short/long press, Short press/long inching.
- Key Control Type: Scene, Sequence, Timer Switch, Universal switch, Single channel lighting control, Broadcast scene, Broadcast channel, Curtain Control, GPRS Control, Panel Control, Security Module, Z-audio Control
- Built-in temperature sensor.
- It has Key lock, mutually exclusive and key linkage.
- Customize button labels and plate can be replaced.
- Indicator intensity is adjustable.
- Supports online upgrading.

MP2B-RF.18

NEW PRODUCT



MP4B-RF.18

NEW PRODUCT



MP6B-RF.18

NEW PRODUCT



### Wireless communication

The unit support wireless communication to control multiple targets. 4 wireless power interfaces can be controlled by a single HDL MP(2/4/6/8)-RF module.

### Customizable

The HDL MP(2/4/6/8)-RF has a completely customizable fascia. A user is able to specify both the fascia colour and the material it is to be made out of. This tailoring enables the module to fit seamlessly into any room.

### Customize different plate and frame color



White glass  
2 button switch

White glass  
4 button switch

White glass  
6 button switch

White glass  
8 button switch



## Wireless Power Interface

MPWPI03.18

The wireless power interface supplies wireless panels with 5v DC. Dimming is possible through 2 TRIAC dimming channels, and 1 MOSFET trailing edge dimming channel. The module also has short circuit protection, and over-heat protection.



### Without neutral line

The HDL-MPWI03.18 is specifically designed to supply power to wireless panels without neutral line. This is an optimised supply that is best suited to the panels, it enhances device stability, and enables peak panel performance.

### Protected

Safeguards are integral to any HDL device, and the HDL-MPWI03.18 is no different. Dual system guards are given through short circuit protection and overheating protection. The DC power is isolated with AC power to ensure the user operation security. These preventative measures stop potentially dangerous situations occurring, and enhance user peace of mind.

### Triple channels

With 1 MOSFET dimming channel, and 2 TRIAC dimming channels, users are able to tailor the system to their exact specifications. All of the three channels can trigger dimming, and switching, making them suitable for a wide range of applications.

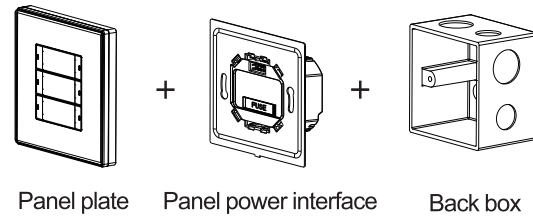

Panel plate + Panel power interface + Back box

## Wireless Ceiling Mount Ultrasonic & PIR Sensor

MSPU05-RF.1C

MSPU05-RF.1C

**NEW PRODUCT**



This module is both a PIR and ultrasonic sensor utilizing wireless communication protocols. Several logic inputs can be used to control multiple targets, and the module can be connected to other security modules.

## Parameters

- Working power: AC220V
- Detection range: 6m (Installation height: 3m)
- Communication: Wireless
- Installation: Ceiling mount
- Dimension: Ø95\*37(mm)

## Functions

- Built-in Temperature sensor, PIR sensor, LUX sensor, Ultrasonic sensor, as well as Universal switch, Dry contact and logic control totally 8 logic input conditions
- With 24 logic blocks, each logic block have 8 input and 20 output commands; Each logic block has two universal switch inputs, can totally set 48 universal switches
- Variety Control includes scene switch, sequence switch, universal switch, signal channel adjust, audio, curtain, GPRS panel control, background music control, etc
- Two logic relationships: OR, AND
- Adjustable infrared sensitivity, sensitivity range:1-100
- Adjustable ultrasonic sensitivity, sensitivity range:1-100
- Security function, to be used with the security module.
- Supports wireless online upgrading.

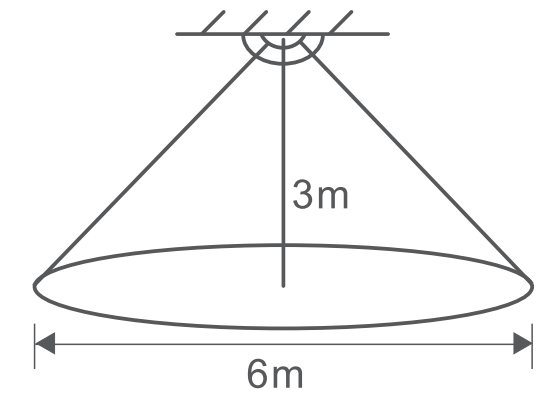

Detection range

**NEW PRODUCT**

MPWPI03.18



## Parameters

- Working power: AC85-270V
- Frequency: 50/60Hz
- Wireless transmit power: +10dbm
- Wireless receive sensitivity: -90dbm
- Output: 3 channels
- Output current: 1A/CH, total current should not exceed 2A
- Fuse: 4A aR type
- Terminal: Wago 236
- Dimension: 84\*84\*39(mm)

## Functions

- Supplies DC5V power for wireless panels
- 1CH MOSFET Dimmer Dimming/Switch
- 2CH TRIAC Dimming/Switch
- Short circuit protection
- Over heating protection



# Wireless Gateway Module

MCIP-RF02.10

NEW PRODUCT

MCIP-RF02.10



As a wireless gateway module the MCIP-RF02.10 can support RJ45, HDL-Buspro, and RF, and create a meshed network using standard IEEE 802.15.4. The frequency can then be selected from between 768, 868, and 900 MHz. The module is also able to create a transmission bridge between devices, extending the FR scope. Via the on board buttons RF parameter setting is enabled.

## Parameters

• Working power: 12~30VDC
• Communication: RJ45, HDL Buspro, Wireless
• Wireless transmit power: +10dbm
• Wireless receive sensitivity: -90dbm
• Communication distance indoor: 50m (barrier free)
• Work mode: Mesh mode, bridge mode
• BUS Terminal: 0.75-0.85mm Diameter Single Core
• Additional function: RF433MHz receiving

## Triple communication interfaces

The wireless MCIP-RF02.10 Gateway supports three essential communication types, RJ45, HDL-Buspro, and RF. These communication methods allow a user to control the wireless system via a pad or smart phone, while maintaining conventional wired system functionality.



RJ45

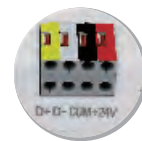

HDL-BUS



WIRELESS

## Wireless Central Frequency

• (China) WPAN: 780MHz-786MHz

• (Europe) SRD: 864MHz-870MHz

• (North America) ISM: 904MHz-928MHz

## Dual Working Modes

With two working modes the gateway is suitable for any automation solution. The first mode is the mesh network mode; this mode enables all the wireless devices active on the network to connect to each other. The mesh also supports wired system integration through the RJ45 and HDL Buspro ports.

The second mode is bridge mode; the function of this mode is to act as a transmission bridge. This enables multiple gateways and their associated wired devices to communicate with each other wirelessly. The scope of the system can then be further extended via RF.

### Mesh network working mode

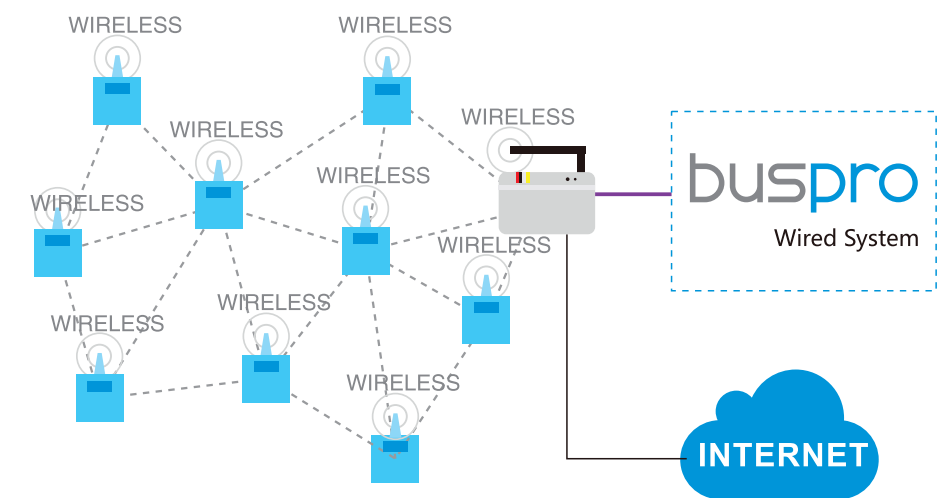

### Bridge working mode

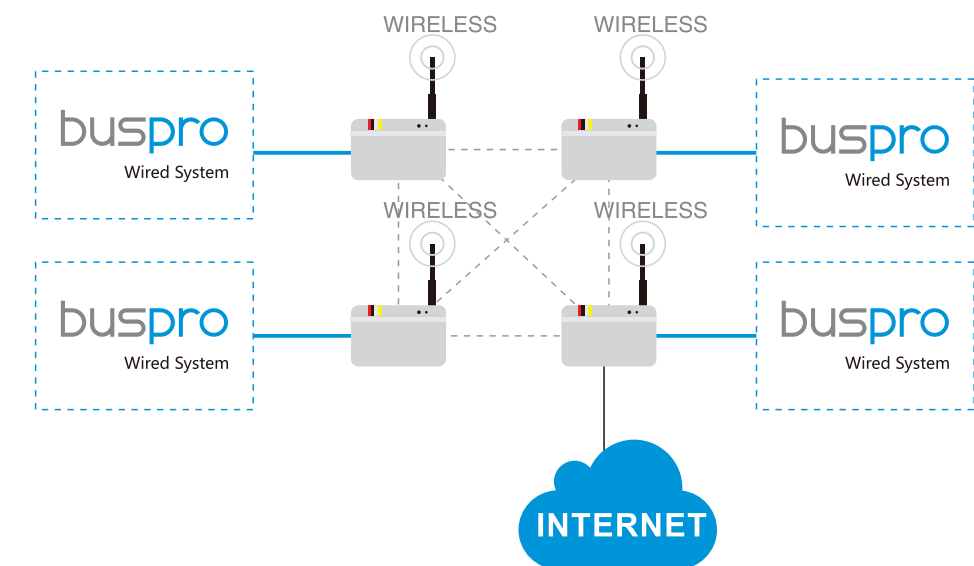



# Wireless 1 Channel Motorized Curtain

MWM70-RF.12



MASTER



NEW PRODUCT MWM70-RF.12



SLAVE



MWM70S.12

## Common Parameters

• Voltage range: AC220V±20% 50Hz
• Slave interface: 6P network interface
• Rated power: 70W
• Rated torque: 1.0Nm
• Rated speed: 112rpm
• Line speed: 16cm/s
• Communication : wireless
• Insulation class: E
• IP class: IP41

## Special parameters for MASTER

• Power supply: AC220V
• Communication: Wireless
• Master interface: RJ11(6P6C) network port

## Special parameters for SLAVE

• Bus working voltage: DC12V
• BUS Power Consumption : 33mA/DC 12V
• Power supply: Provide from master
• Slave interface: RJ11(6P6C)network port

The module is a wireless motorized curtain controller, which supports both master and slave modules. The unit utilizes standard IEEE 802.15.4 wireless communication protocols, with frequencies of 768, 868, and 900 MHz. The new generation clutch and planetary reducer gears, enable the controller to operate at a barely audible 40db.

## Technical Specifications

- Direct-powered by 220V AC, Maximum pulling force 8Kg(one motor), maximum curtain weight 50Kg (one motor), 80Kg (2 motors).
- Built-in new generation clutch, precise planetary reducer, noise level 40dB.
- Percentage control enabled.
- Drag and run enabled, can be disabled.
- Integrated with multiple user interfaces, HDL panel, iLife on iPad, Touchlife on Android pad, Touchlife on 7-inch touch screen.
- Suitable for all small to medium-scale curtain applications, linear and arched, one- and two-side opening.
- Recommended maximum track length 12m; refer to load curves below



## Functions

- Over LOAD protection. The curtain will stop in case of external disturbance
- Supports the following control commands: Open, Close, Stop and Percentage
- Included additional pieces to adjust the curtains to the supports
- Easy programming for control panels and switches
- Supports manual mode when the power off
- Motor running mode: forward or reverse
- Pulse coding for position control

- OverHEAT protection. In case of high temperature, the motor will switch off temporarily
- The position of the curtain can be measured and displayed in user interfaces
- Optional function of automatic calibration when power on
- Trigger manually the Open and Close of the curtain
- Solid and robust structure with modern style
- Supported Master and Slave mode
- Extremely silence working mode

## Load curves(one-motor type)

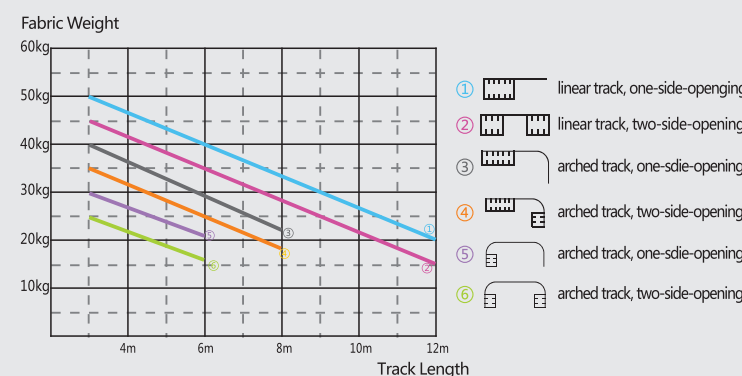

## Load curves(two-motor type)

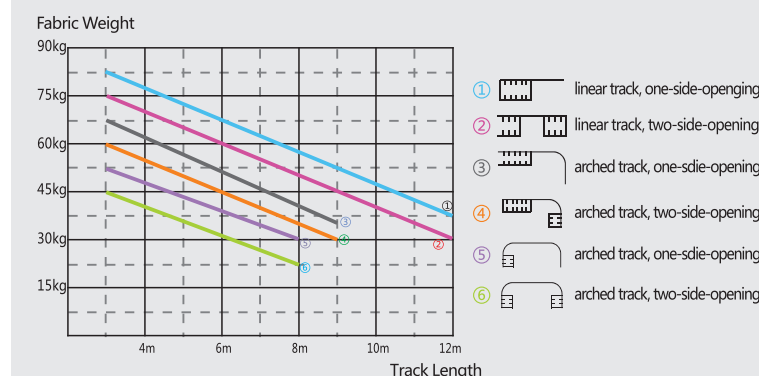



## 1/2CH Relay

MPR01-RF.18 /MPR02-RF.18

## 1CH Trailing Dimmer/4 CH Dry Contact Input

MPD01-RF.18/MPS04-RF.18

NEW PRODUCT

MPR01-RF.18



### Parameters

- Input voltage: AC85-265V
- Output current: 16A (COSΦ=0.4)
- Power consumption:Max. 0.41W
- Wireless transmit power:+10dbm
- Wireless receiving sensitivity:-90dbm
- Communication distance indoor:<=30m (barrier free)
- Installation: Wall box
- Dimensions: 44x36x17(mm)

MPR02-RF.18

NEW PRODUCT



### Parameters

- Input voltage: AC85-265V
- Output current: 8A (COSΦ=0.4)
- Power consumption: 0.45W max.
- Wireless transmit power:+10dbm
- Wireless receiving sensitivity:-90dbm
- Communication distance indoor: <=30m (barrier free)
- Installation: Wall box
- Dimensions: 44x36x17(mm)

NEW PRODUCT

MPD01-RF.18



### Parameters

- Input voltage: AC85-265V
- Output current: 1.5A
- Power consumption:Max. 0.58W
- Wireless transmit power:+10dbm
- Wireless receiving sensitivity:-90dbm
- Communication distance indoor:<=30m (barrier free)
- Installation: Wall box
- Dimensions: 44x36x20.2(mm)

MPS04-RF.18

NEW PRODUCT



### Parameters

- Input voltage: AC85-265V
- Power consumption:Max. 0.44W
- Wireless transmit power:+10dbm
- Wireless receiving sensitivity:-90dbm
- Communication distance indoor:<=30m (barrier free)
- Installation: Wall box
- Dimensions: 44x36x17(mm)







**HDL**®

buspro

Buspro is a distributed communication bus protocol based on the RS-485 standard, which enables control of all building appliances, and integration with third party software and hardware. It allows technologies to merge and can be expanded in a simplistic manner.

## 1 Channel Tubular Blind Controller

MVSM45B.12



### Common Parameters

- Power Supply: DC16~30V
- Rated voltage: AC220V±20% 50Hz
- Static direct-current power: 0.7W
- Dynamic direct-current power: 1.2W
- Working voltage range: AC190~235V
- Working current: 0.6A
- Rated power: 140W
- Rated torque: 10N.m
- Rated speed: 17r/min
- Terminal: HDL Buspro
- dB: 42dB
- Insulation class: E
- IP class: IP41

### Functions

- Can control to open, close, stop and percentage control
- Communication: HDL Buspro
- AC motor is power source, provide enough power, it can make the torque of tubular motor big enough
- Overheat protection
- Supports online upgrading
- Supports easy programming

MVSM45B.12

NEW PRODUCT



The MVSM45B.12 is a tubular blind controller, which has been designed to automate all common roller blinds. The unit can output 10 Nm of torque giving an effortlessly smooth action, and operates at a barely audible 42dB.



### ↑↓ High torque

Using a single phase AC motor the unit can effortlessly control blinds via its 10 Nm of torque. To provide a user with the ultimate in blind control, the unit has percentage control; stop, up and down control.

### 🛡️ Reliable

To increase reliability and service life, the MVSM45B.12 utilizes overheat protection. This safeguards not only the unit itself, but the system it is integrated into.





# 1 CHANNEL MOTORIZED CURTAIN

MWM70B.12 / MWM70S.12

# Motorized Curtain Controller

MWM70.12



MASTER



MWM70B.12



SLAVE



MWM70S.12

## Technical Specifications

- Direct-powered by 220V AC, Maximum pulling force 8Kg (one motor), maximum curtain weight 50Kg(one motor), 80Kg(2 Motors)
- suitable for all small to medium-scale curtain applications, linear and arched, one-and two-side opening
- recommended maximum track length 12m; refer to load curves below

## Common Parameters

• Power Supply: AC220V±20% 50HZ
• Rated power: 70W
• Rated torque: 1.0Nm
• Rated speed: 112rpm
• Line speed: 16cm/s
• Insulation class: E
• IP class: IP41

## Common Parameters

• Voltage range: AC220V±20% 50HZ	• Rated speed: 112rpm
• Rated power: 70W	• Line speed: 16cm/s
• Rated torque: 1.0Nm	• Dimensions: 284×70×50(mm)
• IP class: IP41	• Insulation class: E

This module serves as new motorized curtain controller, needs to work with HDL 2 channel curtain module (SB-DN-2Motor).



MWM70.12

**NEW PRODUCT**

## Functions

- Overload protection and overheat protection
- Support forward, reverse, stop and percentage control
- 40dB extremely silence working mode with built-in new generation clutch, precise planetary reducer
- Optional function of automatic calibration when power on
- Supports manual mode when the power off
- Pulse coding for position control
- Supported Master and Slave mode
- Trigger manually the Open and Close of the curtain
- Integrated with multiple user interfaces, HDL panel, iLife on iPad, Touchlife on Android pad, Touchlife on 7 inch touch screen

## Special parameters for MASTER

• Bus working voltage: DC15-24V
• Bus power consumption : 40mA/DC 24V
• Communication interface: HDL-Buspro
• Master interface: RJ11(6P6C)network port

## Special parameters for SLAVE

• Bus working voltage: DC12V
• BUS Power Consumption : 33mA/DC 12V
• Power supply: Provide from master
• Slave interface: RJ11(6P6C)network port

## Functions

- Built-in new generation clutch, precise planetary reduce, noise level 40dB
- Suitable for all small to medium-scale curtain applications, linear and arched, one-and two-side -opening
- The motor has three modes; they are forward, reverse, and stop
- the interval between activating and deactivating the curtain is less than 100ms

### Load curves(one-motor type)

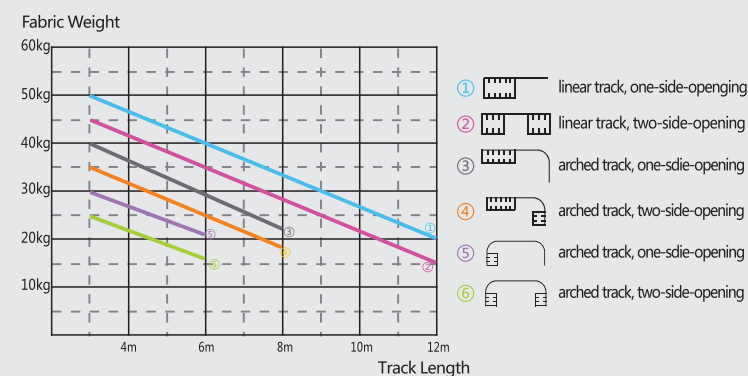

### Load curves(two-motor type)

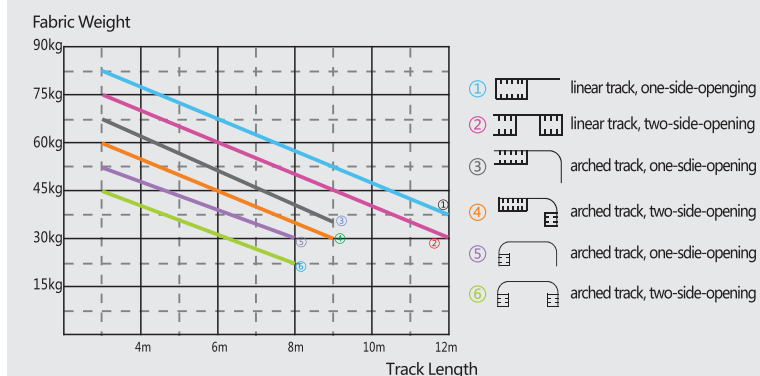



# HDL MUSIC PLAY BOX

MZBOX.20 / MZAP.20

HDL music play box is an elegant device to manage your music and playlists from many different sources. The client can create a personalised environment in which to enjoy their favorite music.

HDL Audio Amplifier provides an excellent solution for you in those places where you need to use more power to supply your music equipment.

MZBOX.20



White/Grey Black/Light Blue

MZAP.20



White/Grey Black/Light Blue

## Parameters

- Power Supply : DC24-48V
- Static Power : 1.6W
- Audio input Voltage : 0.7VPP
- Input Resistance 50KΩ
- Output Resistance : 32Ω
- Output Power : 20mW × 2
- Harmonic distortion : < 0.05%
- SNR : 97dB
- Frequency Range : 22Hz - 20KHz
- File name length : ≤25 bytes
- Music Format:MP3
- SD Card Capacity: ≤ 32 G
- Dimension : 180mm×180mm×37mm
- Communication : FTP, UDP

## Functions

- External Input: Availability to connect any external input through Mini Jack Port, Audio IN port/Audio OUT port
- Internal SD Card : Up to 32 GB
- FTP Server: Availability to use FTP/UDP remote server through Ethernet
- FM Radio: Possibility to use external FM antenna in order to improve the signal
- Bluetooth input: Supports Bluetooth 2.0
- S/PDIF Optical Fiber Input: Supports S/PDIF Optical Fiber Input
- Capacitive touch buttons: Easy to control music play box locally
- Dry contact to control audio amplifiers
- Availability to use IR emitter to control devices such as DVD, third part audio amplifier
- The Touch Panel technology adjusts automatically to the changing environmental conditions such as humidity and temperature.
- Supports online upgrading.

## Parameters

- Power Supply : DC24-48V
- Audio input Voltage : 0.7VPP
- Audio output Resistance : 32Ω
- Output Resistance : RL = 4Ω
- RR = 4Ω
- Output Power=50W × 2
- Harmonic distortion <0.05%
- SNR=97dB
- 4 class Gain control, : 25.6dB, 31.6dB, 35.6dB, 37.6dB

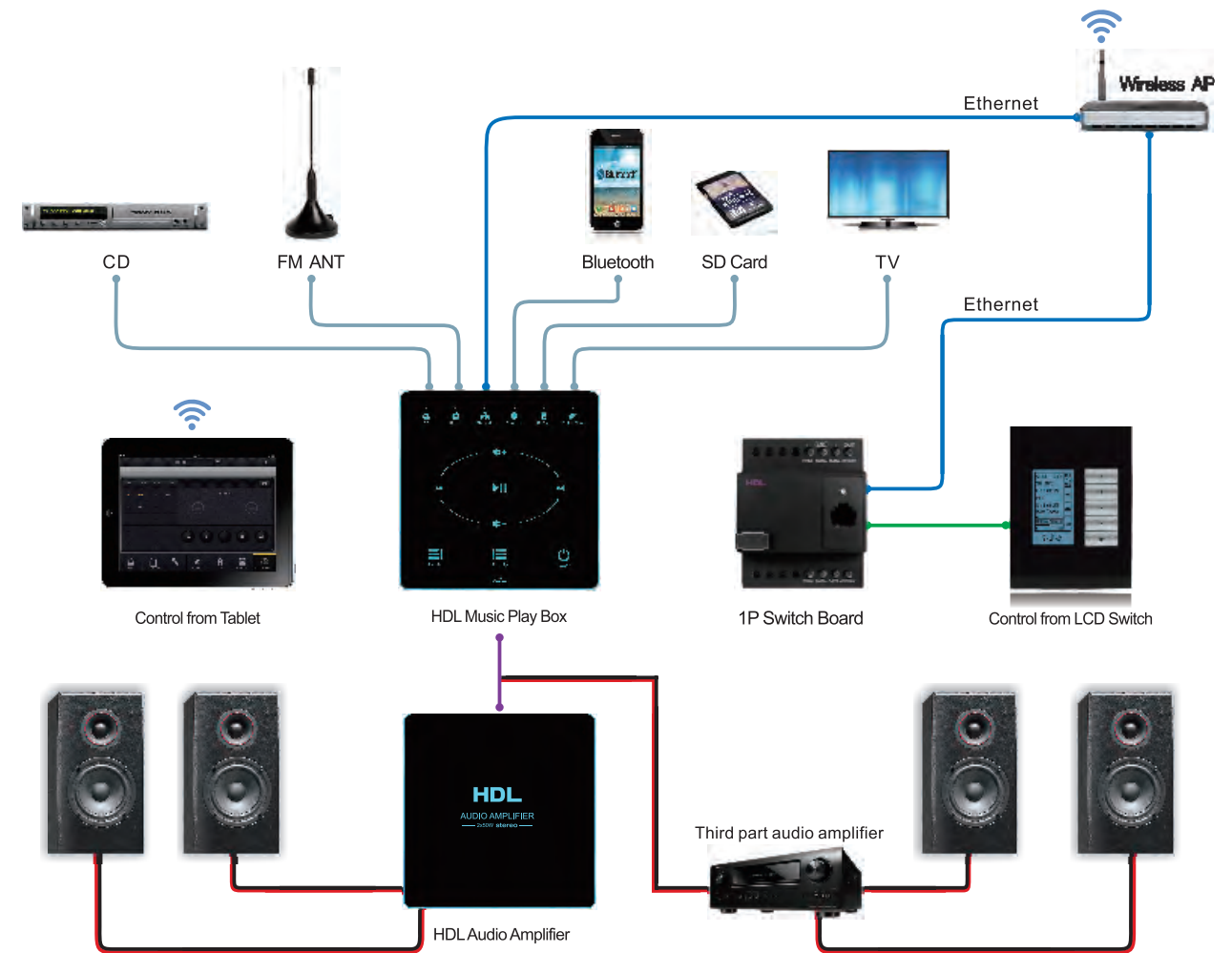



# 10" Color Home Control Touch Screen

MTS10A.2WB



NEW PRODUCT

MTS10A.2WB



- 4 channels relay output, each channel is 1A, max. DC30V
- Supports 6 channels dry contact input
- Supports iLife control
- Rj45 communication
- Supports POE IEEE 802.3af
- Built-in RTC
- Buzzer control
- Scene control
- Supports SIP
- Supports Android apps

## Parameters

- Power supply: 12~30VDC POE IEEE 802.3af
- Power: Max. 15W
- CPU: Samsung Exynos 4412 1.4GHz ARM Cortex-A9 quad-core
- DDR: 2GB DDR3
- Flash: 8GB iNand
- Communication protocol: Buspro
- Touch screen: Capacitive screen
- Screen dimensions: 10.1 inch
- Screen resolution : 1280\*800
- Screen ratio : 16:9
- Operation system : Android 4.0.4
- Ethernet port : RJ45 10/100 M
- SD card : Max. 32GB
- Camera : 5.0 megapixel, 2592x1944
- Dimensions : 269.2×209.2×39(mm)
- Installation : Wall box



• Main interface



• Air Control



• TV Control

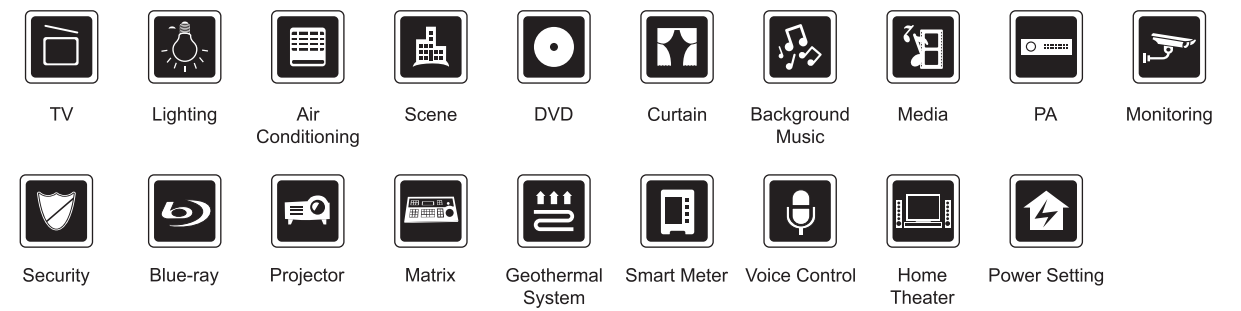



# Touch DLP Panel

MPTL14.46

## Points For The 'touch' DLP Panel



### 7 Different Pages

With 7 separate and easy to navigate pages, a user can take complete control over their lighting, air conditioning, back ground music, floor heating, and security. Each of the pages has 8 buttons providing effortlessly smooth control, and 2 dedicated scrolling buttons. In addition to this located on the bottom of the panel are four customizable shortcut keys, giving you fast and intuitive system navigation.

### Customizable

Every aspect of the DLP can be customised, from the on screen icons to the fascia colour, allowing the touch panel to be tailored to any environment or situation. A personalised logo or engraving can even be added to the screen to give you a truly unique solution.

### Flush Mount

When the DLP touch panel is coupled with the flush mount system, the panel projects a mere 3mm from the wall. This seamless integration between panel and building has been designed to ensure that the panel is an organic element of the building, and does not intrude upon the aesthetics of a room.

### Multi-functional

The DLP touch panel is able to do more than control every system and device in a building. With it's built in temperature sensor, data can be sent to the thermostat allowing each room to be monitored independently. This ensures that your heating and cooling solutions are optimized, and work as efficiently as possible.



### Customize different plate and frame color

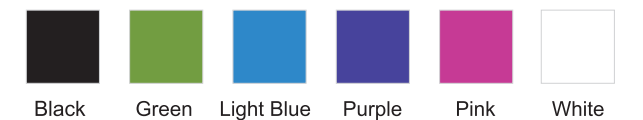

## What's your favorite color?

### Your Company's Logo In The Switches

Give an excellent branding for your company using customized front plates with the logo of your company or the corporate colors.

### Choose The Color That Defines Your Home's Personality

We provide the possibility to print out layout colors, picture or image texture on the front plate that suit your lifestyle or with your interior designer's project. colors.

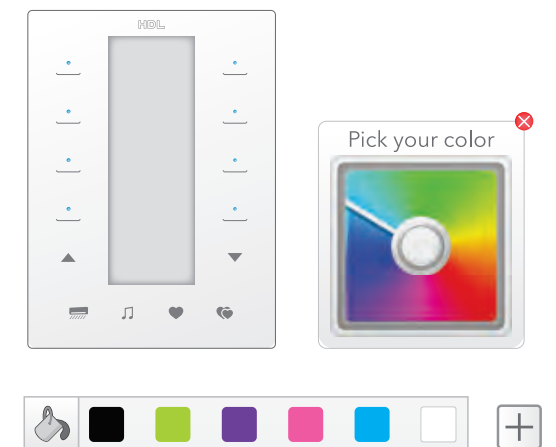

NEW PRODUCT

MPTL14.46

## Parameters

- Working power:12~30VDC
- DC Current:45mA/24VDC
- Bus Terminal: 0.75-0.85mm Diameter Single Core
- Housing Material:Glass , ABS, PC
- Installation: GI Wall-Box
- Dimensions:86×116.5×10.5 (mm)





# Enviro Panel

MPTLC43.46

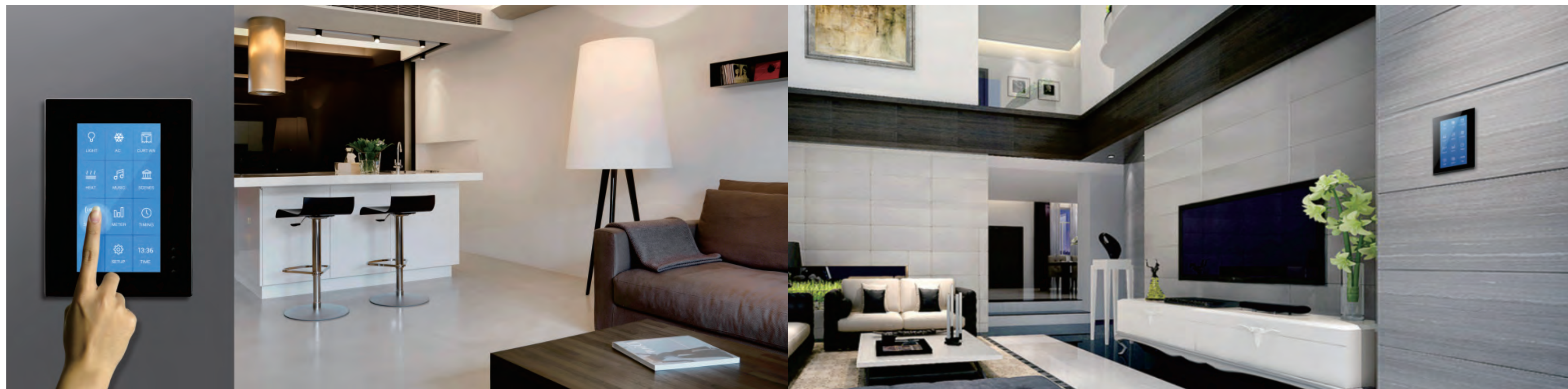

NEW PRODUCT

MPTLC43.46



## Parameters

- Working voltage: DC12~30V (From HDL-MPPI.46)
- Power consumption: 85mA /DC24V
- Terminal: 0.75-0.85mm Diameter Single Core
- Housing Material: Glass, PC, ABS
- Installation: GI Wall Box
- Dimensions: 86×116.5×10.5 (mm) (Normal) 96×126.5×10.5 (mm) (XL)

## ENERGY MANAGEMENT

The crowning feature of the Enviro panel is its ability to monitor in real time the electrical and water resources being consumed. This is particularly useful if a user is trying to cut down on their energy usage, or if they simply wish to be notified of excessive energy use.

## 12 LISTING PAGES

With a massive 12 listing pages users can control hundreds of targets in their building. These listing pages use large easy to read fonts, are capable of displaying 147 languages, and use universally acknowledged icons.

## 4.3" CAPACITIVE LCD

Sporting a 4.3 inch capacitive touch LCD screen, the Enviro Panel allows a user to know at a glance exactly what systems are active. The screen also boasts a cool blue back lit display that is capable of being constantly active, allowing fast location detection in dim or unfamiliar conditions.

## MUTIPLE TARGETS

Users can take complete control over every feature of their building, with a single Enviro Panel. From lighting, curtains, music, scenes, sensors, timers, AC, floor heating, and even security solutions. This effortless control enables a user to know exactly what feature or appliance is being used and where.





## Touch Buttons Switch EU

MPT4.48

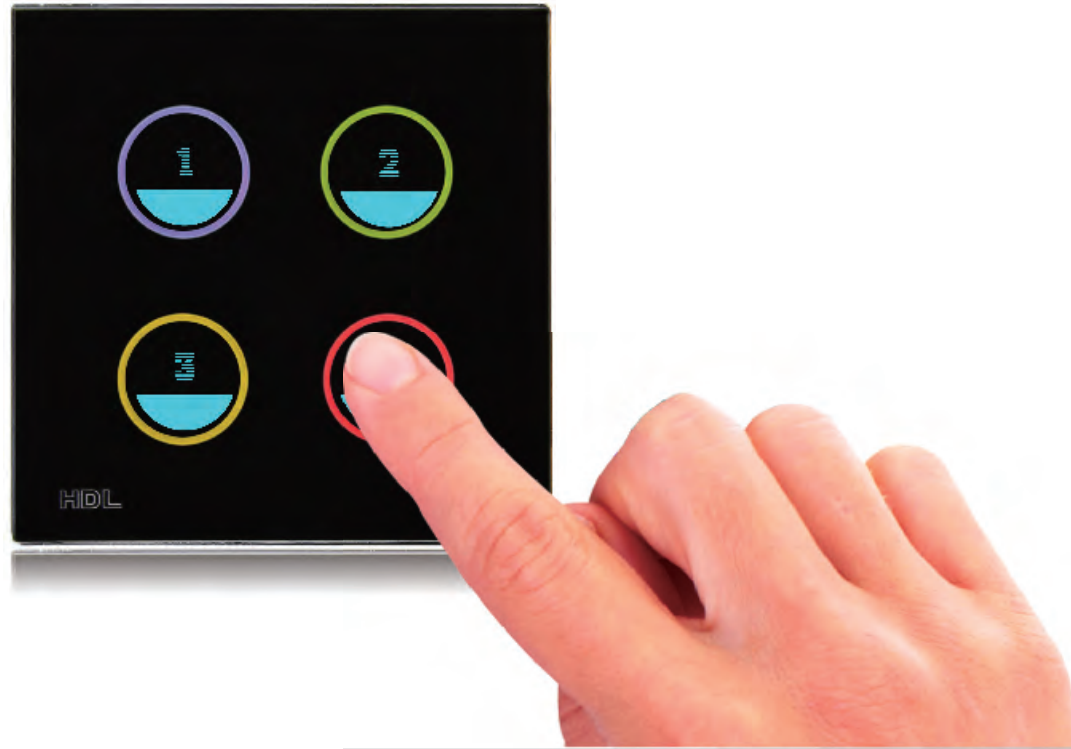

### The back-light button lights up when it is touched

Each touch button has two-colour custom status which can be infinitely adjusted via the RGB value. The Touch Panel technology adjusts automatically to the changing environmental conditions such as humidity and temperature. Also other parameters such as the back-light's brightness and saturation are adjustable.

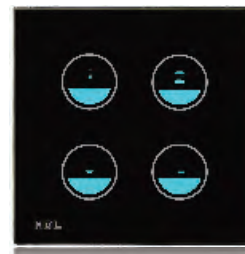

Status without backlight color

### The color, icons and pattern of the plate can be customised



Based on your personal favorites or your requirements



Orange Glass Blue Glass Light Green Glass Golden Glass



All RGB color are selectable

## Touch Buttons Switch EU

MPT1.48 / MPT2.48 / MPT3.48

### Parameters

- Power supply: DC12-30V
- BUS power consumption: 20mA/DC24V
- Installation: Wall mounting
- Dimensions: 86×86×10.5(mm)

### Functions

- Working with MPPI.48 panel power interface
- 1/2/3/4 touch control buttons
- Multi modes for button: Single on/ off, single on, single off, combination on, combination off, combination on/off, double click/ single on/ off, double click/combination on/off, momentary, short press/long press, short press/long momentary etc.
- Multi control types for button: Scene, sequence, timer, universal switch, single channel control, curtain, GPRS, panel, broadcast scene, broadcast channel, security module, music
- Adjustable RGB backlight
- Combination function for : Single on off, combination on/off
- Support easy programming
- Support HDL Buspro online upgrading



### IR Remote Control

Built-in IR receiver (You need to replace a plate with an IR receiving hole to enable the IR remote control function)

MPT1.48



MPT2.48



MPT3.48





# DLP Switch EU

MPL8.48

MPL8.48

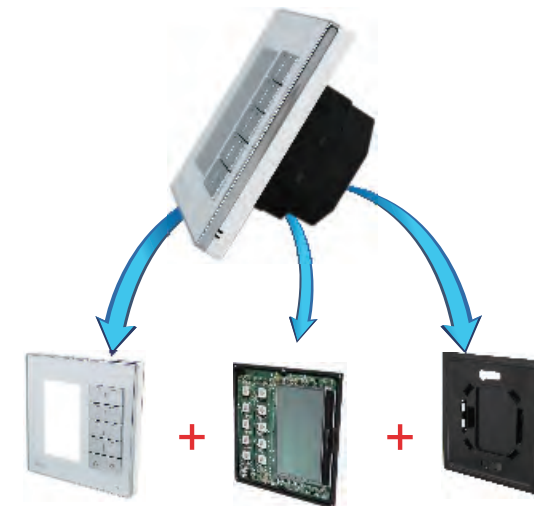

## Customise your DLP

Based on your personal favourites or your individual requirements

- Selectable Plate
- Selectable Frame

## Parameters

- Power supply: DC12-30V
- BUS power consumption: 30mA/DC24V
- Installation: Wall mounting
- Dimensions: 86×86×10.5(mm)

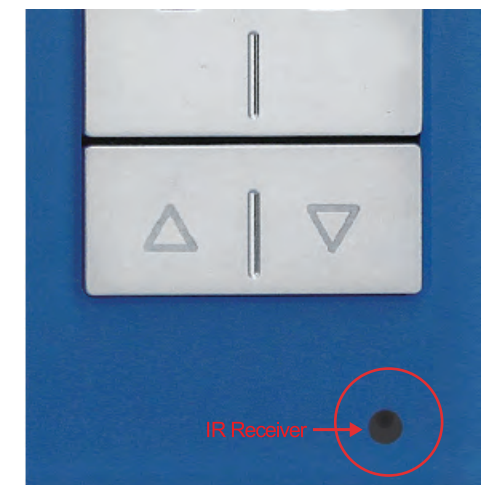

## IR Remote Control

Built-in IR receiver (You need to replace a plate with an IR receiving hole to enable the IR remote control function)

## New generation DLP

New design features such as metal buttons with four left/right keys (in total eight individual buttons) which you can merge together and configure their LEDs. The frame and plate are selectable with different materials and colours to fit in with your lifestyle.

With just one DLP you can control your whole house. Up to 32 buttons distributed through four pages, you can control up to 99 targets with each button, and in total more than 3000 targets like lighting, curtain, blinds, HVAC, heating system, background music, etc.

The new firmware supports 147 different languages, has a user-friendly interface, and provides easy programming functions as well. The DLP panel allows connections with dimmers, relays, curtains, etc. directly without software. All the buttons have the ability to record the state of the rest of buttons and create with them new scenes in the DLP panel. This special function makes creating and changing scenes easy for the end user



## Functions

- Working with MPPI.48 panel power interface
- 8 control buttons, 2 page buttons, button combine function
- Multi Modes for button: Single on/ off, single on, single off, combination on, combination off, combination on/off, double click/ single on/ off, double click/combination on/off, momentary, clock timer, short press/long press, short press/long momentary, "hyperlink" etc
- Multi control types for button: Scene, sequence, timer, universal switch, single channel control, curtain, GPRS, panel, broadcast scene, broadcast channel, security, music
- IR remote control, adjustable LCD back light
- Floor heating, air conditioning and music control
- Support HDL Buspro online upgrading



# Intelligent Switch EU

MP01R.48 / MP02R.48 / MP03R.48 / MP04R.48

MP01R.48



MP02R.48



MP03R.48



MP04R.48



## Parameters

- Power supply: DC12-30V
- BUS power consumption: 20mA/DC24V
- Installation: Wall mounting
- Dimensions: 86×86×10.5(mm)

## Functions

- Working with MPPI.48 panel power interface
- 1/2/3/4 control buttons
- Multi modes for button: Single on/ off, single on, single off, combination on, combination off, combination on/off, double click/ single on/ off, double click/combination on/off, momentary, short press/long press, short press/long momentary etc.
- Multi control types for button: Scene, sequence, timer, universal switch, single channel control, curtain, GPRS, panel, broadcast scene, broadcast channel, security module, music
- Adjustable RGB backlight
- Combination function for : Single on off, combination on/off
- Support easy programming
- Support HDL Buspro online upgrading

## Background

Switchers are elements very important when you design a new space. That's why we want to give the possibility to customize the plate and frame to find the style which suits you best

### Customize different plate and frame color



## Buttons

Small details are important because they give a distinguished touch of luxury and fashion to your home and business. To feel identified with these values, you can change the button's ring colors to adjust it with your house style or your color business.

### Choose the style of the buttons



## Selectable Plate Materials

The feeling of touch of Bronze and Glass are unique. If you are trying to avoid common materials, you can use the materials for your switchers which it matches better with your style.



## Two custom color status per button



The back-light button lights up when it is pressed. Each button has two custom color status which can be infinitely adjustable via the RGB value by software.



## 8 Buttons Switch EU

MP8B.48



### DIY Concept

### Do It Yourself

Selectable plate and frame this is ideal in situations where you may need to regularly change or adjust the functionalities of different buttons.

The text on the buttons is easily adjustable, removable, and replaceable to suit your individual and changing needs. You simply print what you want, fix it to the button and cover it with the plastic sleeve.

This also makes it a very economical option as opposed to committing yourself to ones with design at the outset.

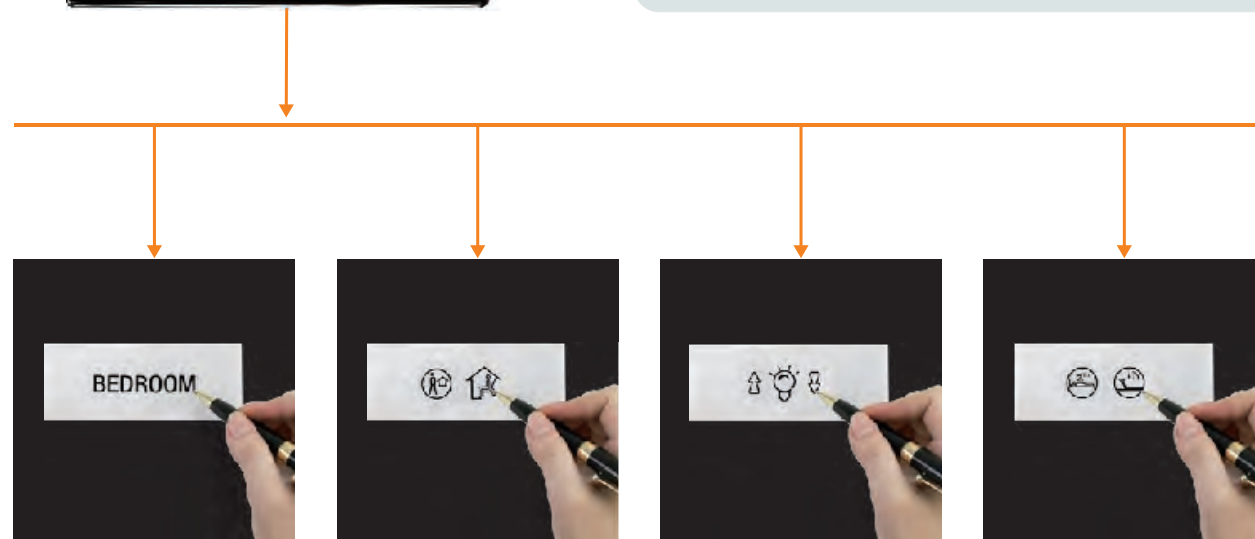

## 2/4/6 Buttons Switch EU

MP2B.48 / MP4B.48 / MP6B.48

### Parameters

- Power supply: DC12-30V
- BUS power consumption: 15mA/DC24V
- Installation: Wall mounting
- Dimensions: 86×86×10.5(mm)

### Functions

- Working with MPPI.48 panel power interface
- 4/6/8 control buttons
- Multi modes for button: Single on/ off, single on, single off, combination on, combination off, combination on/off, double click/ single on/ off, double click/combination on/off, momentary, short press/long press, short press/long momentary etc.
- Multi control types for button: Scene, sequence, timer, universal switch, single channel control, curtain, GPRS, panel, broadcast scene, broadcast channel, security, music
- Customize button labels
- Key lock function
- Key led status can be adjustable
- Support easy programming
- Support HDL Buspro online upgrading

MP2B.48



MP4B.48



MP6B.48



### IR Remote

### Control

Built-in IR receiver (You need to replace a plate with an IR receiving hole to enable the IR remote control function)

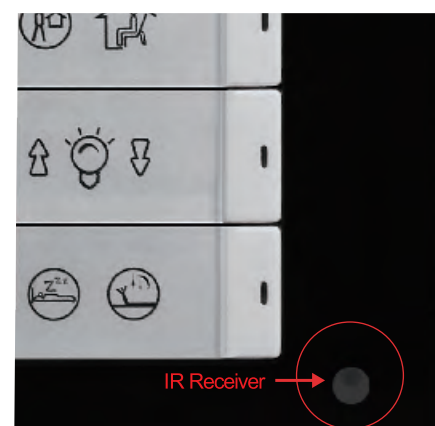

### Customize different plate and frame color



White glass  
8 button switch

White glass  
6 button switch

White glass  
4 button switch

White glass  
2 button switch



## 4/6/8 Buttons Switch EU

MP4B.48 / MP6B.48 / MP8B.48

## 4 /8 buttons Panel EU

MP4A.48 / MP8A.48

MP4B.48



### Parameters

- Power supply: DC12-30V
- BUS power consumption: 15mA/DC24V
- Installation: Wall mounting
- Dimensions: 86×86×10.5(mm)

### Functions

- Working with MPPI.48 panel power interface
- 4/6/8 control buttons
- Multi modes for button: Single on/ off, single on, single off, combination on, combination off, combination on/off, double click/ single on/ off, double click/combination on/off, momentary, short press/long press, short press/long momentary etc.
- Multi control types for button: Scene, sequence, timer, universal switch, single channel control, curtain, GPRS, panel, broadcast scene, broadcast channel, security, music
- Customize button labels
- Key lock function
- Key led status can be adjustable
- Support easy programming
- Support HDL Buspro online upgrading

MP6B.48



Color of plate and frame is selectable and customizable



White glass 2 button switch    White glass 4 button switch    White glass 6 button switch    White glass 8 button switch



### Parameters

- Power supply : DC12-30V
- BUS power consumption : 15mA/DC24V
- Installation: Wall mounting
- Dimensions : 86×116.5×10.5(mm)

### Functions

- Working with MPPI.48 panel power interface
- 2/4 big button, total 8/4 control button
- Multi modes for button : Single on/ off, single on, single off, combination on, combination off, combination on/off, momentary, double click/ single on/ off, double click/combination on/off, on/off, short press/long press, etc
- Multi control types for Button: Sscene, sequence, timer, universal switch, single channel control, curtain, GPRS, panel, broadcast scene, broadcast channel, security module, music
- Key lock function
- Key led status can be adjustable
- Support easy programming
- Support HDL Buspro online upgrading

MP4A.48



MP8A.48

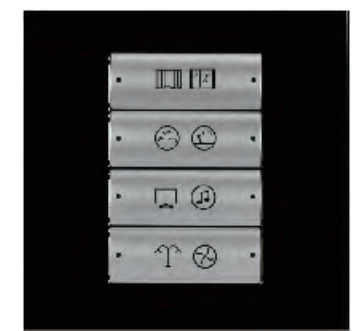

Note: Built-in IR receiver, need to replace a plate with IR receiving hole to achieve IR remote control function

Color of plate and frame is selectable and customizable



White glass/4 button switch    White glass/8 button switch

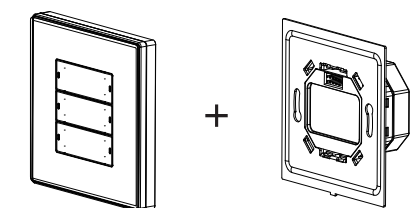

Installation diagram



## Double Panels

COMBINE TWO USER INTERFACE IN ONE PLATE

### Double up the functionalities in an elegant way

You can avoid a scattered, untidy look by having two panels next to each other, and at the same time bring all of your required functionalities into the one place.



### Easy and economic solution to extend your BUS



• Dimensions : 172x86x10.5(mm)

This is also a very cheap solution, as you only need to extend the bus cable by a few centimeters to reach the adjacent panel. It gives you the advantage of less construction work and ugly drilling and chasing for separately-placed panels

### Create a double panel combining two user interfaces

We can have the individual plates finished to whatever color or template you require. The two panels can be color-coordinated to your individual requirements and aligned neatly for optimum esthetic appearance.



## Intelligent Switch EU

MP6CN.48 / MP13CN.48

### Parameters

- Power supply: DC12-30V
- BUS power consumption: 16mA/DC24V
- Installation: Wall mounting
- Dimensions: 86×86×9(mm)

### Functions

- Working with MPPI.48 panel power interface
- 7/14 control button
- Multi modes for button: Single on/ off, single on, single off, combination on, combination off, combination on/off, double click/ single on/ off, double click/combination on/off, momentary, short press/long press, short press/long momentary etc.
- Multi control types for button: Scene, sequence, timer, universal switch, single channel control, curtain, GPRS, panel, broadcast scene, broadcast channel, security, music
- Customize button labels
- Key lock function
- Key led status can be adjustable
- Support HDL Buspro online upgrading

MP6CN.48



MP13CN.48



### Customize different plate and frame color





## Modern Series Intelligent Switch EU

MPH101.48 / MPH102.48 / MPH104.48 / MPH108.48

MPH101.48



### Parameters

- Power supply : DC12-30V
- BUS power consumption : 15mA/DC24V
- Installation: Wall mounting
- Dimensions : 86×86×23(mm)

### Functions

- Multi Modes for Button: Single on/ off, single on, single off , combination on, combination off, combination on/off , Momentary, double click/ single on/ off , double click/combination, on/off, etc
- Multi control types for Button: Scene, sequence, timer, universal switch, single channel control, curtain, GPRS, panel, broadcast scene, broadcast channel, security module, Music, etc.

MPH102.48



MPH104.48



MPH108.48



- Dimensions : 172x86x23(mm)

## Intelligent Switch EU

MPHG01.48 / MPHG02SA.48 / MPHG03A.48

MPHG01.48



### Parameters

- Power supply : DC12-30V
- BUS power consumption : 20mA/DC24V
- Installation: Wall mounting
- Dimensions : 86×86×9(mm)

### Functions

- Working with MPPI.48 panel power interface
- 1/2/3 control button
- Multi modes for button: Single on/ off, single on, single off, combination on, combination off, combination on/off, double click/ single on/ off, double click/combination on/off, momentary, short press/long press, short press/long momentary etc.
- Multi control types for button: Scene, sequence, timer, universal switch, single channel control, curtain, GPRS, panel, broadcast scene, broadcast channel, security, music
- Customize button labels
- Key lock function
- Key led status can be adjustable
- Support easy programming
- Support HDL Buspro online upgrading

MPHG02SA.48



MPHG03A.48





## Touch Button Switch US

MPT2.46 / MPT4.46 / MPT6.46

MPT2.46



MPT4.46



MPT6.46



### Parameters

- Power supply : DC12-30V
- BUS power consumption: 20mA/DC24V
- Installation: Wall mounting
- Dimensions: 86×116.5×10.5(mm)

### Functions

- Working with MPPI.46 panel power interface
- 2/4/6 control button
- Multi modes for button: Single on/ off, single on , single off , combination on, combination off, combination on/off , momentary, double click/ single on/ off , double click/combination, on/off, etc
- Multi control types for Button: Scene, sequence, timer, universal switch, single channel control, curtain, broadcast scene, broadcast channel, etc.
- Single on, single off, combination on, combination off can be set to key-relevancy.
- Backlight value adjustable • Color of Backlight (RGB) can be set
- Support easy programming
- Support HDL Buspro online upgrading

### Color of back board support RGB/ Selectable face plate and frame



white glass/2 button touch switch    white glass/4 button touch switch    white glass/6 button touch switch

Note: Built-in IR receiver, need to replace a plate with IR receiving hole to achieve IR remote control function

## Aluminum Style Switch US

MP2K.48 / MP4K.48 / MP6K.48 / MP8K.48

MP2K.48

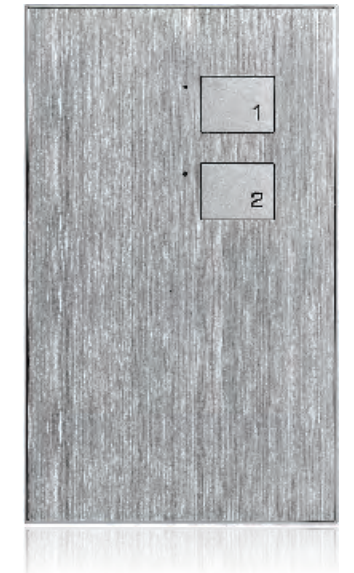

MP4K.48



### Parameters

- Power supply : DC12-30V
- BUS power consumption : 15mA/DC24V
- Installation: Wall mounting
- Dimensions : 73×120×9(mm)

### Functions

- Working with MPPI(K)48 panel power interface
- 2/4/6/8 control buttons
- Multi modes for button : Single on/ off, single on, single off, combination on, combination off, combination on/off , momentary, double click/ single on/ off , double click/combination, on/off, short press/long press, etc
- Multi control types for button: Scene, sequence, timer, universal switch, single channel control, curtain, GPRS, panel, broadcast scene, broadcast channel, security module, music
- Support easy programming
- Support HDL Buspro online upgrading

### Selectable QTY Button

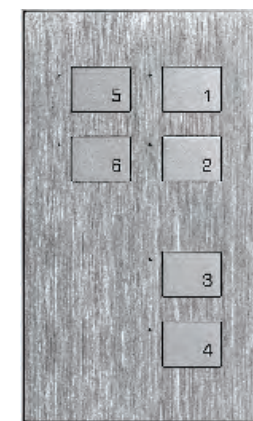

6button / MP6K.48



8button / MP8K.48



# DLP Switch US

MPL8.46

MPL8.46



Air conditioning control interface



- Metal Buttons
- Electronic Labels
- Selectable Plate
- Selectable Frame

## Parameters

- Power supply: DC12-30V
- BUS power consumption: 30mA/DC24V
- Installation: Wall mounting
- Dimensions: 86×116.5×10.5(mm)

## Functions

- Working with MPPI.46 panel power interface
- 8 control buttons, 2 page buttons, button combine function
- Multi Modes for button: Single on/ off, single on, single off, combination on, combination off, combination on/off, double click/ single on/ off, double click/combination on/off, momentary, clock timer, short press/long press, short press/long momentary, "hyperlink" etc
- Multi control types for button: Scene, sequence, timer, universal switch, single channel control, curtain, GPRS, panel, broadcast scene, broadcast channel, security, music
- IR remote control, definable LCD back light
- Floor heating, air conditioning and music control
- Support easy programming
- Support HDL Buspro online upgrading

## Multiple Control Pages



Lighting

Background Music

Floor Heating

Built-in IR receiver, need to replace a plate with IR receiving hole to realize IR remote control function

# 4/6/8 Buttons Switch US

MP4B.46 / MP6B.46 / MP8B.46

MP4B.46



MP6B.46



MP8B.46



## Parameters

- Power supply: DC12-30V
- BUS power consumption: 15mA/DC24V
- Installation: Wall mounting
- Dimensions: 86×116.5×10.5(mm)

## Functions

- Working with MPPI.46 panel power interface, 4/6/8buttons
- Multi Modes for Button: Single on/ off, single on, single off, combination on, combination off, combination on/off, double click/ single on/ off, double click/combination on/off, Momentary, short press/long press, short press/long momentary etc.
- Multi control types for Button: Scene, sequence, timer, universal switch, single channel control, curtain, GPRS, panel, broadcast scene, broadcast channel, security module, music
- Customize button labels
- Key lock function
- Key led status can be adjustable
- Support easy programming
- Support HDL Buspro online upgrading

## Customize different plate and frame color



White glass  
2 button switch

White glass  
4 button switch

White glass  
6 button switch

White glass  
8 button switch

Built-in IR receiver, need to replace a plate with IR receiving hole to realize IR remote control function



## 4/6/8 Buttons Switch US

MP4B.46 / MP6B.46 / MP8B.46

MP4B.46



MP6B.46



MP8B.46



### Parameters

- Power supply: DC12-30V
- BUS power consumption: 15mA/DC24V
- Installation: Wall mounting
- Dimensions: 86×116.5×10.5(mm)

### Functions

- Working with MPPI.46 panel power interface
- 4/6/8 control buttons
- Multi modes for button: Single on/ off, single on, single off, combination on, combination off, combination on/off, double click/ single on/ off, double click/combination on/off, momentary, short press/long press, short press/long momentary etc.
- Multi control types for button: Scene, sequence, timer, universal switch, single channel control, curtain, GPRS, panel, broadcast scene, broadcast channel, security, music
- Customize button labels
- Key lock function
- Key led status can be adjustable
- Support easy programming
- Support HDL Buspro online upgrading

### Customize different plate and frame color



White glass 2 button switch    White glass 4 button switch    White glass 6 button switch    White glass 8 button switch

## 4 / 8 buttons Switch US

MP4A.46 / MP8A.46 / MP4A.46/ MP8A.46

### Parameters

- Power supply : DC12-30V
- BUS power consumption : 15mA/DC24V
- Installation: Wall mounting
- Dimensions : 86×116.5×10.5(mm)

### Functions

- Working with MPPI.46 panel power interface
- 4/2 big button, total 8/4 control button
- Multi modes for button: Single on/ off, single on, single off, combination on, combination off, combination on/off, momentary, double click/ single on/ off, double click/combination, on/off, short press/long press, etc
- Multi control types for button: Scene, sequence, timer, universal switch, single channel control, curtain, GPRS, panel, broadcast scene, broadcast channel, security module, Music
- Key lock function
- Key led status can be adjustable
- Support easy programming
- Support HDL Buspro online upgrading

### Selectable face plate and frame

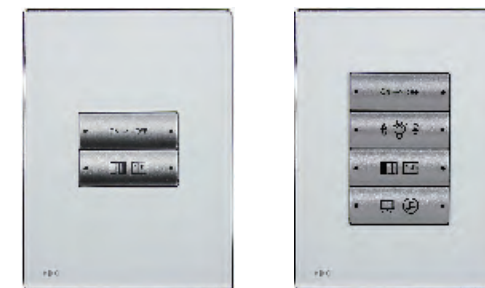

MP4A.46

MP8A.46

MP4A.46



MP8A.46



Note: Built-in IR receiver, need to replace a plate with IR receiving hole to achieve IR remote control function

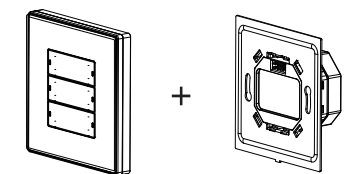

Installation diagram



## Panel Power Interface

MPPI.46 / MPPI(k).48/ MPPI.48

MPPI.46 / MPPI(k).48



MPPI.46

MPPI(k).48

### Parameters

- Power supply : DC12-30V
- Installation: Wall mounting
- Dimensions: H83.5mm x W114.5mm x D 26.5mm(MPPI.46)  
H73mm x W120mm x D 26.5mm(MPPI(k).48)

### Functions

- Panel power interface, working with new panel plate US
- HDL Buspro interface, fast connector need to use HDL Buspro/KNX cable

Installation diagram

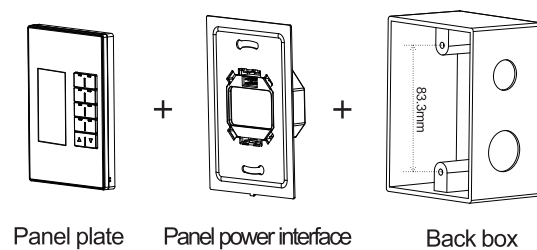

Panel plate

Panel power interface

Back box

MPPI.48



### Parameters

- Power supply : DC12-30V
- Installation: Wall mounting
- Installation: Standard GI and EU box
- Dimensions: H83.5 x W83.5 x D 26.5(mm)

### Functions

- Panel power interface, working with new panel plate EU
- HDL Buspro interface, fast connector need to use HDL Buspro/KNX cable

Installation diagram

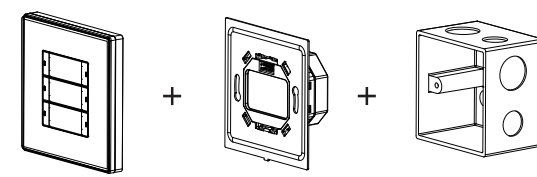

Panel plate

Panel power interface

Back box

## High Performance Dimmer

SB-WL-D0610 / SB-WL-D0620 / SB-WL-D1210

### Parameters

- Power supply : 3 phase (L1, L2,L3, N,PE)
- Power input: AC220V±10%
- Protection: Overload protection
- Installation : Wall hanging

### Functions

- 10 bit dimming Accurate;
- Hardware bypass function;
- Up to 6/12 separate scenes
- Up to 99 scenes in each area, maximum runtime of scene is 60 minutes
- Up to 99 sequence, 99 steps in each sequence; each sequence has 60 minutes as interval time;there are four types of sequences: Forward/Backward/Ramdom/Forward&Backward
- Low, high or maximum threshold are available to suit the different loads in each channel;
- Emergency bypass in each channel;
- Remark information provided in each scene, area, channel and sequence;
- With fire emergency switch
- Can go back to previous scene or designated scene once the system restart

SB-WL-D0610



- Output channel 6 channel dimming
- Dimensions : 470x290x162(mm)
- Current in each channel: each channel 10A; total less than 60A
- Maximum 6 separate areas
- Can provide 200mA current to BUS

SB-WL-D0620



- Output channel: 6 channel dimming
- Dimensions: 600 x290x162(mm)
- Current in each channel: each channel 20A; total less than 120A
- Maximum 6 separate areas
- can provide 200mA current to BUS

SB-WL-D1210



- Output channel: 12 channel dimming
- Dimensions: 600 x290x162(mm)
- Current in each channel: each channel 10A; total less than 120A
- Maximum 12 separate areas
- Can provide 200mA current to BUS

# Leading / Trailing Edge MOSFET Dimmer

MDT0203.433 / MDT04015.433

NEW PRODUCT

MDT0203.433



- Output channel : 2ch/3A
- Fuse: 10A aR type
- Maximum 2 separate areas, each area has 12 scenes
- Dimmer is based on the technology of MOSFET. It has
- 2 output channels and manual switch is available for each channel. Each channel can choose leading edge or trailing edge by software. This is very useful when user has different type of loads. And it has short circuit protection and over heat protection

## Parameters

- Power supply : AC110/240V
- BUS Working voltage : DC12-30V
- BUS power consumption : 25mA/DC24V
- Dimming curves: linear,  $x^{1.5}$ ,  $x^{2.0}$ ,  $x^{3.0}$
- Dimensions : 216×90×66(mm)

## Functions

- Maximum 2/4 separate areas, each area has 12scenes
- Each output channel has LED indicator for status and manual switch
- Maximum 6 sequences, and 12 steps for each sequence
- Low Threshold, High Threshold, Maximum Threshold are all available for each channel
- Each channel can choose leading edge or trailing edge
- Can select specified scene or scene before power off when the device restarts
- Short circuit and over heat protection
- 4 dimming curves
- Supports online upgrading

NEW PRODUCT

MDT04015.433



- Output channel : 4ch/1.5A
- Fuse: 8A aR type
- Maximum 4 separate areas, each area has 12 scenes
- Dimensions : 216×90×66(mm)
- Dimmer is based on the technology of MOSFET. It has
- 4 output channels and manual switch is available for each channel. Each channel can choose leading edge or trailing edge by software. This is very useful when user has different type of loads. And it has short circuit protection and over heat protection

# Leading / Trailing Edge MOSFET Dimmer

MDT0601.433 / MCR01.40

NEW PRODUCT

MDT0601.433



## Parameters

- Power supply : AC110/240V
- BUS Working voltage : DC12-30V
- BUS power consumption : 25mA/DC24V
- Dimming curves: linear,  $x^{1.5}$ ,  $x^{2.0}$ ,  $x^{3.0}$
- Dimensions : 216×90×66(mm)

## Functions

- Maximum 6 separate areas, each area has 12scenes
- Each output channel has LED indicator for status and manual switch
- Maximum 6 sequences, and 12 steps for each sequence
- Low Threshold, High Threshold, Maximum Threshold are all available for each channel
- Each channel can choose leading edge or trailing edge
- Can select specified scene or scene before power off when the device restarts
- Short circuit and over heat protection
- 4 dimming curves
- Supports online upgrading

TRIAC Constant Current Load  
MCR01.40



## Parameters

- Power supply : DC 0-240V
- Load constant current : < 15mA
- Working condition : Working temp : 0°C~45°C  
Working relative humidity : up to 90%  
Storage temperature : -20°C~+60°C  
Storage relative humidity : up to 93%
- Dimensions : 37.4×26.7×22.6(mm)

## Functions

- 1 load channel
- 15mA constant current
- Working with TRIAC dimmer
- Connected in parallel when working with the lamp

Diagram of constant current

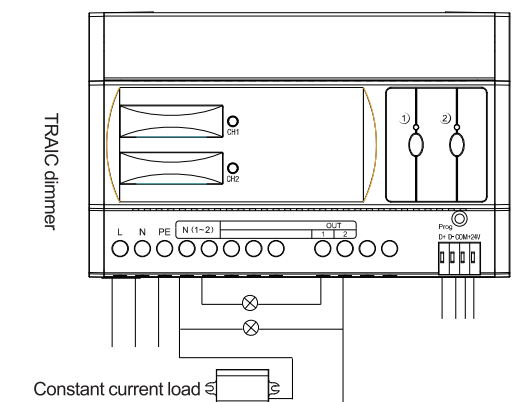

Note: above picture is set HDL TRIAC dimmer as an example, the module can supply minimum 15mA current for TRIAC, this module can solve the flicker problem when dimming the Lamps such as some LEDs and low voltage Halogen.



## Leading Edge TRIAC Dimmer

MD0206.432 / MD0403.432 / MD0602.432

MD0206.432



- Output channel: 2ch/6A
- Fuse: 10 A aR type
- TRIAC: 25A bidirectional TRIAC , minimum load 40W
- Maximum 2 separate areas, each area has 12 scenes

MD0403.432



- Output channel: 4 ch/3A
- Fuse: 8 A aR type
- TRIAC: 25A bidirectional TRIAC , minimum load 40W
- Maximum 4 separate areas, each area has 12 scenes

MD0602.432



- Output channel: 6ch/2A
- Fuse: 4 A aR type
- TRIAC : 16A bidirectional TRIAC , minimum load 40W
- Maximum 6 separate areas, each area has 12 scenes

## Parameters

- Power supply: 110/240V±10%
- BUS Working voltage: DC12-30V
- BUS power consumption: 28mA/DC 24V
- Dimming curves: linear,  $x^{1.5}$ ,  $x^{2.0}$ ,  $x^{3.0}$
- Dimensions: 144X90X66 (mm)

## Functions

- Maximum 6/4/2 separate areas, each area has 12 scenes
- Maximum 6 sequences, each sequence has 12 steps
- 512 dimming step, 4 dimming curves
- Low, high or max threshold are available in each channel to suit the different loads;
- Manual buttons ON and OFF for each channel
- Can go back to previous scene or designated scene once the system restart
- Short circuit protection over temperature protection
- Support easy programming
- Support HDL Buspro online upgrading

## Leading Edge TRIAC Power Amplifier

SB-WL-B0120 / SB-WL-B0210

SB-WL-B0120



SB-WL-B0210



## Parameters

- Power supply : AC 220V±10%
- Protection : Need exterior protection switch
- Output channel: 1 channel dimming output
- Output current : 20A
- Installation: wall hanging
- Dimensions : 288x200x100(mm)

## Functions

- Dimmable power amplifier
- AC0-240v power input
- DC 0-10V control signal input

## Parameters

- Power supply : AC 240V±10%
- Protection : Need exterior protection switch
- Output channel: 2 channel dimming output
- Output current : 10A
- Installation: Wall hanging
- Dimensions : 288x200x100(mm)

## Functions

- Dimmable power amplifier
- AC0-240v power input
- DC 0-10V Control signal input

## 10A Relay Module

MR0410.431 / MR0810.432 / MR1210.433 / MR1610.433

MR0410.431



- Output channel: 4 channel Relay
- Dimensions : 72×90×66(mm)
- 4 channel relay output
- Maximum 4 separate areas
- Each area has 8 scenes, maximum runtime of scene: 60 minutes

MR0810.432



- Output channel: 8 channel Relay
- Dimensions : 144×90×66(mm)
- 8 channel relay output
- Maximum 8 separate areas
- Each area has 16 scenes, maximum runtime of scene: 60 minutes

MR1210.433



- Output channel: 12 channel Relay
- Dimensions : 216×90×66(mm)
- 12 channel relay output
- Maximum 12 separate areas
- Each area has 24 scenes, maximum runtime of scene: 60 minutes

MR1610.433



- Output channel: 16 channel Relay
- Dimensions : 216×90×66(mm)
- 16 channel relay output
- Maximum 16 separate areas
- Each area has 32 scenes, maximum runtime of scene: 60 minutes

## 16A Relay Module

MR0416.431 / MR0816.432 / MR1216.433 / MR1616.434

MR0416.431



- Output channel: 4 channel Relay
- Dimensions : 72×90×66(mm)
- 4 channel relay output
- Maximum 4 separate areas
- Each area has 8 scenes, maximum runtime of scene: 60 minutes

MR0816.432



- Output channel: 8 channel Relay
- Dimensions : 144×90×66(mm)
- 8 channel relay output
- Maximum 8 separate areas
- Each area has 16 scenes, maximum runtime of scene: 60 minutes

MR1216.433



- Output channel: 12 channel Relay
- Dimensions : 216×90×66(mm)
- 12 channel relay output
- Maximum 12 separate areas
- Each area has 24 scenes, maximum runtime of scene: 60 minutes

MR1616.434



- Output channel: 16 channel Relay
- Dimensions : 288×90×66(mm)
- 16 channel relay output
- Maximum 16 separate areas
- Each area has 32 scenes, maximum runtime of scene: 60 minutes

### Parameters

- Power supply : DC15-30V
- Static BUS power consumption : 15mA/DC24V
- Dynamic BUS power consumption: 40mA/DC24V
- Current in each channel : 10A
- life time for relay unit : More than 60,000 times
- Protection : Need MCB for each channel
- Installation: Standard 35mm Din Rail
- Capacity load of Relay: < 150μF

### Functions

- 4/8/12/16 channel relay output
- 4/8/12/16 separate areas
- Each area has 8/16/24/32 scenes, maximum runtime of scene: 60 minutes
- Each area has 2 sequences, each sequence has 12 steps
- Each channel has lights protection delay: 0-60 minutes
- Each channel has switch on delay time: 0-25 seconds
- Manual buttons ON and OFF for each channel
- Remote program and management are available
- Can go back to previous scene or designated scene once the system restart
- LED lights available for indicates of each channel
- Staircase lamps function and Mutual exclusion function
- Support easy programming
- Support HDL Buspro online upgrading

### Parameters

- Power supply : DC15-30V
- Power consumption: Static power consumption: 10mA/DC24V  
Dynamic power consumption: 35mA/DC24V
- Current in each channel : 16A
- life time for relay unit : More than 60,000 times
- Protection : Need exterior protection switch
- Installation: Standard 35mm Din Rail
- Capacity load of Relay: < 300μF

### Functions

- 4/8/12/16 channel relay output
- Maximum 4/8/12/16 separate areas,
- Each area has 8/16/24/32 scenes, maximum runtime of scene: 60 minutes
- Each area has 2 sequences, each sequence has 8 steps
- Each channel has lights protection delay: 0-60 minutes
- Manual buttons ON and OFF for each channel
- Remote program and management are available
- Can go back to previous scene or designated scene once the system restart
- Each channel has switch on delay time: 0-25 seconds
- Each area has 2 sequence, the maximum step units of each sequence is same as channel units
- Staircase lamps function and Mutual exclusion function
- Support easy programming
- Support HDL Buspro online upgrading



## LED Driver/ LED Dimmer

SB-WM-LED0304 / SB-LED650mA / MDLED0605.432

SB-WM-LED0304



- Power supply : AC 240V±10%
- Output channel : 3 channel (DC24V 4A)
- dimensions : 310×230×87(mm)

SB-LED650mA



- Power input : DC10-30V
- Output : 650mA
- Dimensions : 96×58.5×22.5(mm)
- 3 output channel for LED Strip
- PWM constant voltage output for LED strip

### Parameters

- Signal interface : DMX512 (1990)
- Installation: Wall hanging

MDLED0605.432



### Parameters

- Power supply : DC15-30V
- Static BUS power consumption : 20mA/DC24V
- Dynamic BUS power consumption: 40mA/DC24V
- Output: 6CH/5A
- LED power input : 12-30VDC
- Dimensions : 144×90×66(mm)

### Functions

- Maximum 6 separate areas, each area has 12 scenes
- Maximum 6 sequences, each sequence has 12 steps, each step has 60 minutes as interval time; there are four types of sequence: Forward/Backward/Random/Forward& Backward;
- Low, high or max threshold are available in each channel to suit the different loads;
- Can go back to previous scene or designated scene once the system restart
- Manual buttons ON and OFF for each channel
- Short circuit protection, over load protection
- 5A output current in each channel
- PWM constant voltage output for LED Lamp and LED strip
- Support easy programming
- Support HDL Buspro online upgrading

## Ballast Dimmer, 0-10V Output

MRDA0610.432

MRDA0610.432



- Current in each relay channel : 10A
- Capacity load : < 150μF
- Support input DC24V
- Sink/output 100mA current for each 0-10v channel, 6 channel total no less than 300mA
- Suitable for 0-10V Fluorescent dimming control
- Suitable for 0-10V LED dimming control

### Parameters

- Power supply : DC 15-30V
- Power consumption : 30mA/DC24V
- Installation: Standard 35mm Din Rail
- Dimensions: 144×90×66(mm)

### Functions

- 6 channel relay output
- Manual buttons ON and OFF for each channel
- LED lights available for indicates of each channel
- Maximum 6 separate areas, each area has 12 scenes
- Maximum 6 sequences, each sequence has 12 steps, each step has 60 minutes as interval time; there are four types of sequence: Forward/Backward/Random/Forward& Backward;
- Low, high or max threshold are available in each channel to suit the different loads;
- Can go back to previous scene or designated scene once the system restart
- Support easy programming
- Support HDL Buspro online upgrading

## DMX Gateway

MBUS-DMX.232

MBUS-DMX.232

NEW PRODUCT



- Introducing DMX Gateway, a gateway unit which integrates HDL-Buspro system with DMX Lighting Control system, enabling control all range of Buspro features as dimmers, relays, etc. from professional lighting desks

### Parameters

- AC input: 230VAC±10%
- BUS power consumption: 200mA/DC24V
- Interface: 128x64 dot matrix graphic LCD 6 manual buttons
- Installation: Standard 35mm Din Rail
- Dimensions: 144x90x66(mm)
- Built-In Ethernet port

### Functions

- Gateway: DMX(DXM512/1990 or ArtNet) to HDL Buspro (one way)
- DMX decode: ArtNet to DMX512/1990
- MAX receivable DMX channel: 48
- Each DMX channel support 16 targets

## How to combine HDL Buspro + DMX Technology + LED Driver

EXAMPLE OF USE

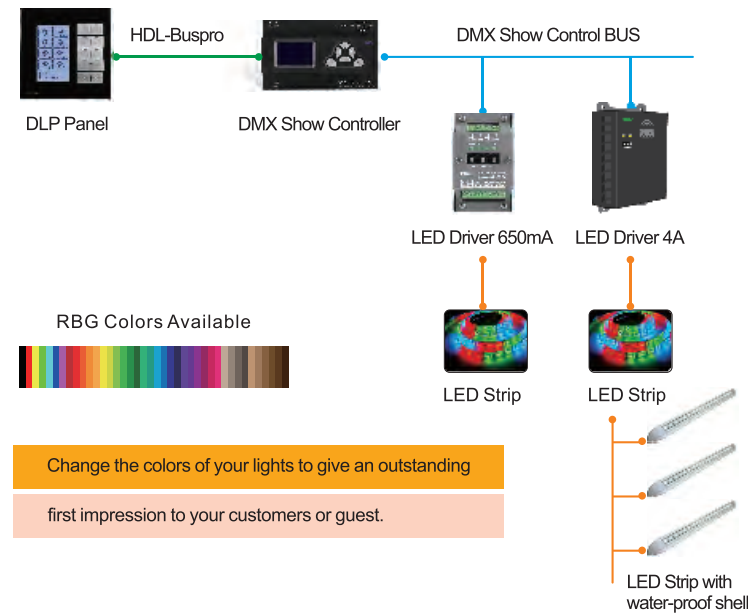

## DMX Scene Recorder

SB-DN-Recorder

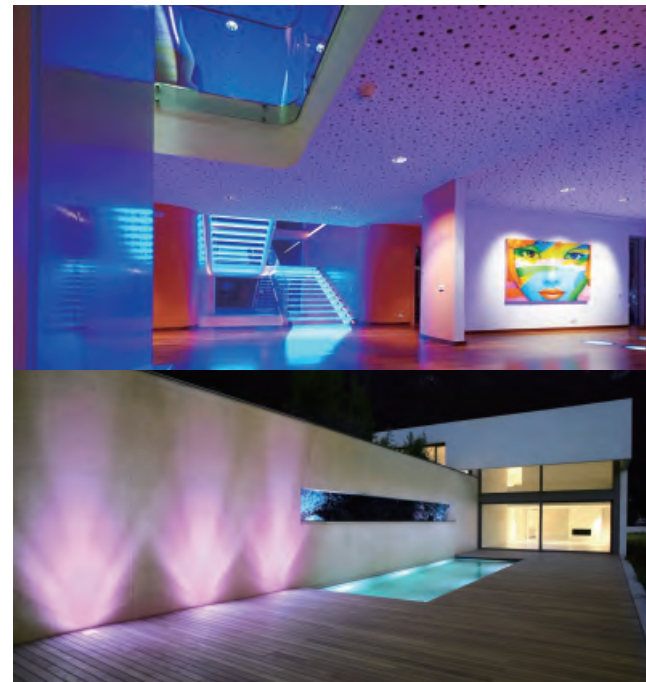

## 48 Channel DMX Controller / 512 channel DMX Show Controller

SB-DN-48DMX / SB-DN-512DMX

SB-DN-48DMX



## Parameters

- Power supply: DC12-30V
- BUS power consumption: 40mA/DC24V
- Installation: Standard 35mm Din Rail
- Dimension: 72x90x66(mm)
- Built in ethernet port

SB-DN-512DMX



## Parameters

- Power supply: DC12-30V
- BUS power consumption: 200mA/DC24V
- Interface: 128x64 dot matrix graphic LCD
- 6 manual buttons
- Installation: Standard 35mm Din Rail
- Dimension: 144x90x66 (mm)
- Built in Ethernet port

SB-DN-Recorder



## Parameters

- Power supply: AC220±10%
- BUS power consumption: 200mA/DC24V
- Interface: 128x64 dot matrix graphic LCD
- 6 manual buttons
- Installation: Standard 35mm Din Rail
- Dimension: 144x90x66(mm)
- Built in Ethernet port

## Functions

- Total capacity: 256Mbyte
- PC remote operation, download programs, play programs, delete programs
- Signal Interface: HDL Buspro, Rj45
- Support ArtNet DMX
- has two play modes single or loop playback
- Wall panel playback
- Up to 4 hours records for programs

## Functions

- Up to 48 areas
- Each area has 99 scenes, maximum scene run time:60 minutes
- Up to 99 sequences, each sequence has 99 steps, maximum step run time: 60 minutes, 4 modes for the sequences "Forward", "Backward", and "Back and forth", "Random".
- DMX512 signal output (1990 version) and HDL-NET DMX output
- Supports self-program and test functions
- Supports remote program and manage functions
- Low, high, max threshold for each channel
- HDL Buspro and Ethernet double way data communication
- Intelligent data exchange, reducing data traffic
- Device can be restored to previous scene or designated scenes

## Functions

- Can be pre-set up to 500 scenes, scene running time from 0.1 second to 60 minutes
- HDL-NET DMX signal output
- Each channel has gradual and abrupt change properties
- HDL Buspro and ethernet double way data communication
- Up to 99 sequences, each sequence has 255 steps, step running time from 0.1 second to 60 minutes, 4 modes for the sequences "Forward", "Backward", and "Back and forth", "Random".
- Soft reset with power on
- DMX512 signal output (1990 version)



## 2 Channel Curtain Module / HVAC Module

SB-DN-2Motor / MAC01.331

## Floor Heating Controller / Logic Controller

MFH06.432 / SB-DN-Logic960

SB-DN-2Motor



### Parameters

- Power supply: DC15-30V
- BUS power consumption: 35mA/DC24V
- Controllable curtain: 2 curtains
- Motor type: Capacitive single phase
- Channel max output current: 5A
- Lifetime for relay unit: 60,000 times
- Installation: Standard 35mm Din Rail
- Dimension: 72x90x66(mm)

### Functions

- 2 channel curtain control
- Hardware and software interlock for forward or backward
- Forward and backward delay

MAC01.331



### Parameters

- Power supply: DC15-30V
- BUS power consumption: 95mA/DC24V
- Max relay current load: 2A
- Installation: Standard 35mm Din Rail
- Dimension: 72x90x64(mm)

### Functions

- Fan speed: High, medium or low
- Control mode : cooling, heating, dehumidification, invalid
- To control AC fan speed and mode smartly by AC control panel
- Temperature measure by connecting with up to 4 pieces of DS18B20
- One master module supports up to 8 slave modules
- DC0-10V fan speed control method
- Support HDL Buspro online upgrading

MFH06.432



### Parameters

- Power supply: DC15-30V
- Dynamic power consumption: 150mA/DC24V
- Static power consumption: 30mA/DC24V
- Output channel: 6
- Maximum channel current: 10mA/DC24V (0-10V output)  
1A/220VAC (Relay output)
- Lifetime for relay unit: 5,000,000 times
- Protection: External breaker
- Dimension: 144x90x66(mm)

### Functions

- 6 channels floor heating or cooling control
- 2 output ways in each channel: relay output and 0-10V output
- Temperature adjustment range: 5°C~40°C (0.5°C accuracy)
- Timing or manually floor heating system flush function by timer or manually
- Support controlling external high power relay modules
- Auto protect from error temperature collection
- Support HDL Buspro online upgrading

SB-DN-Logic960



### Parameters

- Power supply: DC12-30V
- BUS power consumption: 15mA/DC24V
- Installation: Standard 35mm Din Rail
- Dimension: 72x90x66(mm)

### Functions

- Editable daily events
- Maximum 12 logic blocks, each block has 20 logic tables, tables can be connected with each other
- Maximum 4 input conditions and 20 output targets in each logic table
- Logic table input conditions: Time, status of channel, external inputs, universal switch etc
- Logic relations: and, or, nand, nor
- Support HDL Buspro online upgrading

## 64 Channel DALI / GPRS SMS Controller

MC64-DALI.431 / SB-DN-SMS/IP

## 1&3 Phase Digital Power Meter / HDL HUB 6 Lines

SB-DN-PM3P01 / SB-DN-PM1P03 / MBC06.431

MC64-DALI.431



### Parameters

- Power supply: DC12-30V
- BUS power consumption: 15mA/DC24V
- DALI independent power supply: AC110/220V
- Interface: HDL Buspro  
And DALI
- Installation: Standard 35mm Din Rail
- Dimension: 72x90x66(mm)

### Functions

- Transform HDL signal into DALI signal
- Up to 64 DALI channels
- Scene controller
- Support maximum 16 independent areas
- Available function for each channel: Low and high threshold, system failure, DALI component electrify restore
- Fire emergency function
- After device reboot, there is a option to run the designated scene or return back to the last 20 seconds scene before power off
- Support HDL Buspro online upgrading

SB-DN-SMS/IP



### Parameters

- Power supply: DC24V
- BUS power consumption: 60mA/DC24V
- Interface: 128x64 dot matrix graphic LCD  
6 manual buttons
- Installation: Standard 35mm Din Rail
- Dimension: 72x90x66(mm)
- Built in ethernet port

### Functions

- SMS control (99x48 targets)
- Status View
- SMS feedback
- Status alarms
- Background brightness adjustable LED
- Soft reset with power on
- Gateway between HDL Buspro and Ethernet

SB-DN-PM3P01



### Parameters

- Power supply: DC12-30V
- Measuring voltage: 0-250VAC
- Maximum access to current (each channel): Three-phase  
10A / 16A single phase
- BUS power consumption: 60mA/DC24V
- Built-in relay: 2A/250VAC (single phase)
- Installation: Standard 35mm Din Rail
- Dimension: 72x90x66(mm)

### Functions

- You can view real time phase voltage, current, power, active power, reactive power, apparent power, power factor, active power, reactive power, and other values
- Logic function : phase voltage, phase current, time, electrical values of each phase at a certain time , universal switching, all can be logical trigger conditions
- Logical relationships:AND, OR, and trigger delay time can be set
- Data records can be retained for one year

SB-DN-PM1P03



MBC06.431



### Parameters

- Interface: 6 fast connections for HDL Buspro
- Installation: Standard 35mm Din Rail
- Dimension: 72mm x 90mm x 66mm
- Protection: Ip20

### Functions

- Simple method to interconnect 6 different HDL Buspro Lines.
- Easy installation and maintenance



## DC24V Power Supply

SB-DN-PS750 / SB-DN-PS2.4A

## Security Module/Ceiling Speaker Manual

SB-DN-SEC250K

SB-DN-PS750



### Parameters

- Power supply: AC240V±10%
- Frequency: 50-60HZ
- Output current: 750mA
- Output voltage: DC24V
- Installation: Standard 35mm Din Rail
- Dimension: 72x90x66(mm)

SB-DN-PS2.4A



### Functions

- Power supply: AC110/220V±10%
- Frequency: 50-60HZ
- Output current: 2.4A
- Output voltage: DC24V
- Installation: Standard 35mm Din Rail
- Dimension: 144x90x66(mm)

SB-DN-SEC250K



### Parameters

- Working Voltage: DC15-30CV
- Power Consumption: 15mA/DC24V
- Dimmensions: 72mm x 90mm x 66mm
- Installation: Standard 35mm DIN Rail
- Interface: HDL Buspro

### Functions

- 8 Separate zones for different security purposes
- Multiple security modes: Away, Holiday, Daytime, Nighttime, Timing, Etc.
- Multiple alarm modes: Invasion, Gas, Fire, Temperature, Emergency, Etc.
- Multilevel security protection
- Can set up security protection for 8 zones simultaneously
- Availability to check the alarm log
- Send commands to the GPRS SMS Controller or Dial-Out to send SMS messages or call to the emergency contact to ask for help or alarm's notifier in case of security problem
- Online upgrading is available

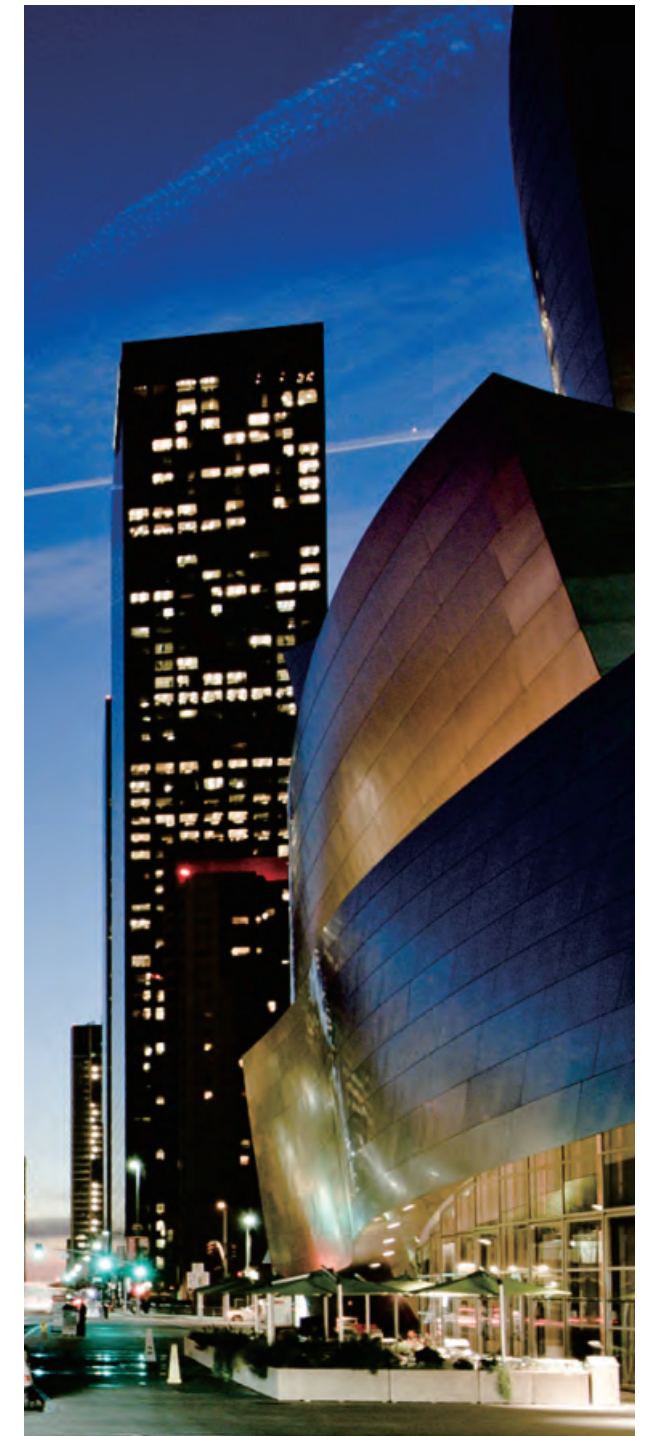

## Ultrasonic & PIR Sensor

MSPU05.48

MSPU05.48



White Black

### Parameters

- Power supply: DC12-30V
- BUS power consumption : 40mA/DC24V
- Ultrasonic sensing range: 6m (diameter)
- Static and dynamic sensing range: 6m (diameter)
- Dimensions : 86X86X31 (mm)

### Functions

- Working with MPPI.48 panel
- Built-in temperature sensor, PIR sensor, LUX sensor, dry contact, ultrasonic sensor, universal switch, logic, total 8 logical conditions
- With 24 logic blocks function, can set 8 input conditions, each logic block can be set 20 targets output
- With 2 optional logical relations: OR, AND
- PIR sensitivity can be adjusted, the sensitivity range is 1-100
- Ultrasonic sensor sensitivity can be adjusted, the sensitivity range is 1-100
- UV switch no. in Logical condition is assigned to 201-248, each logical has 2 UV switch no
- Each logical has time delay 1-3600s
- Support HDL Buspro online upgrading



## Outdoor sensor

HDL-MSOUT.4W

HDL-MSOUT.4W

NEW PRODUCT



### Parameters

- Working voltage: DC12-30V
- Power consumption: 31mA/DC24V
- Temperature detection range: -40°C~60°C
- Illumination detection range: 0~15000LUX
- Humidity detection range: 20~95%RH
- Microwave detection range: H:7m D:10m L:6m
- Housing material: ABS, stainless steel
- Installation: Screw fixation
- Dimensions: 126X78X42 (mm)

### Functions

- Built-in LUX sensor, microwave sensor, humidity sensor, temperature sensor, dry contact, universal switch
- Two logical relations: OR, AND
- It has 24 logic blocks. Both true logic and false logic can trigger the targets respectively. Each logic can set 20 targets
- Adjustable microwave sensitivity, range is 1-100
- Each logic supports trigger delay time from 0 to 3600s
- The range of universal switch number in logic is 201-248, each logic has 2 universal switch numbers, universal switch can close automatically, the time range is 1-3600s
- Tamper-proof function.
- Supports security function
- Sensor has heating function. It can make sure that the circuits can work normally while the temperature is below -5°C
- Supports online upgrading

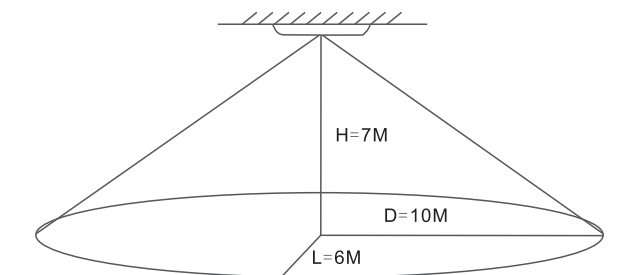

Microwave Detection

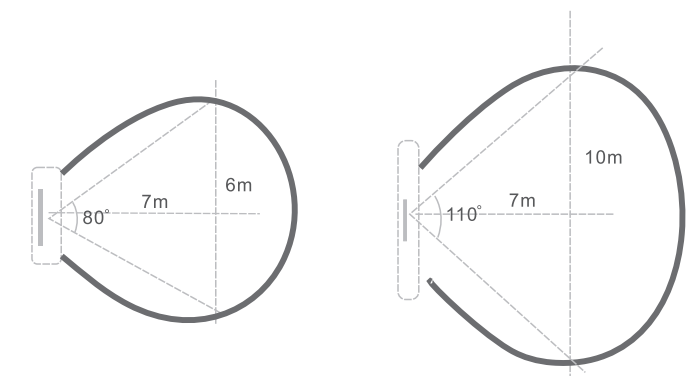

Vertical Direction

Horizontal Direction



## Temperature, Humidity / Wide Field PIR Sensor

SB-CMS-THL / SB-WMS-PIR

SB-CMS-THL



### Parameters

- Power supply: DC12-30V
- Bus power consumption: 25mA/DC24V
- Temperature detection range: -20~36°C
- Illumination detection range: 0~500Lux
- Humidity detection range: 20-95°C
- Installation: Ceiling mount
- Dimension: 80(diameter)x32(mm)

### Functions

- Equipped with brightness sensor, temperature sensor, humidity sensor, two dry contact inputs, two universal switches, logic state etc which can be used as input conditions
- Two logic relations: Or, And
- With up to 24 logic block functions, max eight logic input conditions, up to 20 target outputs for logic conditions
- Security warning function, need to be used with the security module

SB-WMS-PIR



### Parameters

- Power supply: 20mA/DC24V
- Bus power consumption: 15mA/DC24V
- Detection range: 8m
- Detection angle: 110 degrees
- Detection distance adjustment: Software adjustable
- Installation: Wall mount
- Dimension: 106x60.2x60(mm)

### Functions

- Departure delay time from 0 to 36000 seconds
- Master or slave mode
- Security function, to be used with the security module

## 12 in 1 Multi-Function / Air Quality Sensor

SB-CMS-12in1 / SB-CMS-LA

SB-CMS-12in1



### Parameters

- Power supply: DC12-30V
- Static power consumption: 40mA/DC24V (Relay off)
- Dynamic power consumption: 90mA/DC24V (Relay on)
- Signal output: HDL Buspro signal
- Temperature detection range: 0°C~45°C
- Illumination detection range: 0-300 Lux
- PIR sensing range in diameter : 6m (install height-3m)
- Ultrasonic sensor in diameter : 8m
- Installation: Ceiling mount
- Dimension: 110(diameter)x35(mm)

### Functions

- Equipped with a temperature sensor, brightness sensor, infrared motion sensor, ultrasonic sensor, two dry contact inputs, two external input conditions
- With infrared receiver function, can receive eight infrared remote control codes
- With infrared transmitter function, capable of sending 99 infrared remote control codes
- With four logic relations: OR, AND, NOR, NAND
- With up to 32 logic block functions, can be set nine input conditions, each logic block can be set 10 output targets
- 2 relay outputs
- Security function, to be used with the security module
- Support HDL Buspro online upgrading

SB-CMS-LA



### Parameters

- Power supply: DC12-30V
- Bus power consumption: 25mA/DC24V
- Signal interface: HDL Buspro signal
- Temperature detection range: 0°C~45°C
- Illumination detection range: 0-300 Lux
- Air quality detection: cigarettes, cooking odors, hydrogen, carbon monoxide, ethanol, methane, isobutane, alcohol
- Installation: Ceiling mount
- Dimension: 80(diameter)x32(mm)

### Functions

- Equipped with brightness sensor, air quality sensor, two dry contact inputs, two universal switches, logic state etc which can be used as input conditions
- Two logic relations: Or, And
- With up to 24 logic block functions, max seven logic input conditions, up to 20 target outputs for logic conditions
- Security function, to be used with the security module
- Support HDL Buspro online upgrading

## Ceiling Mount Ultrasonic / Ceiling Mount PIR Sensor

MSPU03.4 / MSP02.4C

## HDL 7 IN 1 Sensor / HDL 8 IN 1 Sensor

MSP07M.4C / MSP08M.4C

MSPU03.4C



### Parameters

- Power supply: DC18-30V
- Bus power consumption: 30mA/DC24V
- Detection range in diameter: 8m(Installation height: 3m)
- Temperature detection range: 0°C~45°C
- Illumination detection range: 0-500Lux
- Dimension: 63x63x38(mm)
- Cutting Size: 45mm (Diameter)

### Functions

- Equipped with temperature sensor, brightness sensor, ultrasonic sensor and universal switch which can be used as logic conditions.
- 24 logic blocks, 20 output targets can be set in each logic block.
- Two logic relations: Or, And
- Sensitivity adjustable, range from 1-10
- Universal switch numbers were assigned to 201-248 in the logic conditions, 2 switch numbers for each logic, universal switch has auto-off function(from 1 to 3600 seconds)
- Logic can trigger the control target no matter it's valid or not
- Security function, to be used with the security module
- Support HDL Buspro online upgrading

MSP02.4C



### Parameters

- Power supply: DC18-30V
- Bus power consumption: 20mA/DC24V
- Detection range in diameter: 10m(Installation height: 3m)
- Illumination detection range: 0-300 Lux
- Dimension: 63×63×46.6(mm)
- Cutting Size: 45mm (Diameter)

### Functions

- Equipped with brightness sensor, PIR sensor and universal switch which can be used as logic conditions.
- 24 logic blocks, 20 output targets can be set in each logic block.
- Two logic relations: Or, And
- Sensitivity adjustable, range from 1-10
- Universal switch numbers were assigned to 201-248 in the logic conditions, 2 switch numbers for each logic, universal switch has auto-off function(from 1 to 3600 seconds)
- Logic can trigger the control target no matter it's valid or not
- Security function, to be used with the security module
- Support HDL Buspro online upgrading

NEW PRODUCT

MSP07M.4C



### Parameters

- Power supply: DC18-30V
- Bus power consumption: 25mA/DC24V
- Detection range in diameter: 8m(Installation height: 3m)
- Temperature detection range: -20°C~60°C
- Illumination detection range: 0-500 Lux
- Dimension: 84mm(diameter)×37.5mm

### Functions

- Built-in infrared motion sensor, LUX sensor, dry contact, temperature sensor and universal switch control
- Seven logics for brightness sensor, temperature sensor, PIR sensor, two dry contact inputs and logical condition
- Two logic relations: OR, AND
- Adjustable infrared motion sensitivity, range from 1-10
- It has 24 logic blocks. The range of universal switch number in logic function is 201-248, each logic has 2 universal switch number. The universal switch has Auto-Off function, delay time is 1-3600s
- Logic can trigger the control target no matter it's valid or not. Up to 10 logic block functions to trigger the control target
- Supports upgrade from HDL Buspro
- Constant illuminance function

MSP08M.4C

NEW PRODUCT



### Parameters

- Power supply: DC12-30V
- Bus power consumption: 30mA/DC24V
- IR transmit frequency 38KHz
- Detection range in diameter: 8m(Installation height: 3m)
- Illumination detection range: 0-500 Lux
- Dimension: 84mm (diameter) × 37.5mm

### Functions

- Built-in infrared motion sensor, LUX sensor, IR in/out, dry contact, temperature sensor and external conditions.
- Six logics for brightness sensor, temperature sensor, PIR sensor, two dry contact inputs.
- Two logic relations: OR, AND.
- Adjustable infrared motion sensitivity, range from 1-10.
- It has 20 logic blocks. The range of universal switch number in logic function is 201-240, each logic has 2 universal switch number. The universal switch has Auto-Off function, delay time is 1-3600s.
- Logic can trigger the control target no matter it's valid or not. Up to 10 logic block functions to trigger the control target.
- Up to 240 IR sending control target, the universal switch number is 1-240. It can upload multiple IR code
- Supports upgrade from HDL Buspro
- Constant illuminance function



## RF Receiver / IR/RF Remote Controller

MRF16.4C / MTIRW / MP2N-RF.18

## IR Learner / IR Emitter With Current Detector

SB-IR-Learn.01 / SB-IR-EM

MRF16.4C



### Parameters

- Power supply: DC12-30V
- Frequency of carrier wave: 433.1580MHZ/433.92MHZ
- Bus Power Consumption: 56mA/DC24V
- Receiving distance : 50M
- Dimension: 63 x63x 52(mm)
- Installation: Ceiling Mount

### Functions

- Wireless function : Connect to at most 4 wireless controllers with different addresses, and read the current remote address
- Key mode : single-on/off, single-on, single-off, combined on, combined off
- Maximum 99 objects for each key, 2x8 control keys for each controller (except combine function)
- Control objects : Scene, series, timer, general switch, single channel adjust
- Can set up to 8 different buttons programs
- Support HDL Buspro online upgrading

MP2N-RF.18



- Frequency of carrier wave: 433.92MHZ
- Dimension: 83 x83x 15.4(mm)

No battery switch, working with the receiver module for remote control

MTIRW



### Parameters

- Battery: Lithium (3.7V, 1050mA)
- Working current : 45mA
- Standby current: 1mA
- Frequency of IR: 38KHZ
- Frequency of RF: 433.1580MHZ/433.92MHZ
- IR Sending Distance: 5m
- RF Sending Distance: 50m
- Dimension: 155x60x24.2 (mm)
- USB Interface: Software Upgrade, Charging

### Features

- LCD display, menu-type operation, easy to use
- Built-in Li battery, can be recharged via USB
- Icon can be changed via PC-based tool software
- Support IR and RF emitting, and IR learning.
- Support all HDL button panels
- Support multiple pages, can hide/display page
- Support English and Chinese language
- Support key tone

SB-IR-Learn.01



### Parameters

- Frequency of IR: 38K Hz ± 20%
- Installation: USB 2.0 Interface
- Dimension: 98x70x38(mm)
- For Learning IR codes, sending learned IR codes for test
- USB Interface, no driver for use
- Indicator LED flashing when learning code

### Functions

- USB Interface, no driver and easy to use
- Infrared Code learning
- Infrared Code sending test
- Indicator will flash when the device is learning the IR Code

SB-IR-EM

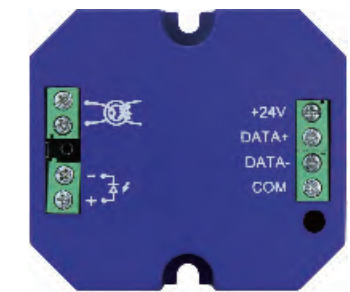

### Parameters

- Power supply: DC12-30V
- BUS power consumption: 15mA/DC24V
- Remote controller code storage: Maximum 200 IR codes
- IR Transmit carrier frequency: 38KHZ
- Dimension: 45x40x13(mm)
- IR remote control signal transmitter
- Detecting state of controlled equipment

### Functions

- Current detecting function for identify device On/Off status
- Maximum 200 IR Codes can be stored
- To send the IR codes by using a IR LED
- Supports upgrade from HDL Buspro

## 1 Port IP Interface / HDL-BUS EIB Gateway

SB-DN-1IP / SB-DN-EIB

SB-DN-1IP



SB-DN-EIB



## HDL-BUS / RS232 Converter

SB-DN-RS232N

SB-DN-RS232N



### Parameters

- Power supply: DC15-30V
- BUS power consumption: 15mA/DC24V
- Installation: Standard 35mm Din Rail
- Signal interface: RS232/HDL Buspro
- Dimension: 72x90x66(mm)
- Support HDL Buspro online upgrading

### Parameters

- Power supply: DC15-30V
- BUS power consumption: 40mA/DC24V
- HDL Buspro subnet numbers: 1 HDL Buspro subnet
- Signal interface: HDL Buspro, RJ45
- Installation: Standard 35mm Din Rail
- Dimension: 72x90x66(mm)

### Parameters

- KNX Power supply: DC15-30V
- KNX power consumption: 5mA/DC24V
- Interface: HDL Buspro  
EIB-BUS (KNX)
- Programming software: HDL Buspro setup tool
- Installation: Standard 35mm Din Rail
- Dimension: 72x90x66(mm)

## Professional Rs232 module

SB-DN-232IP-Pro

### Functions

- Power supply: DC12-30V
- BUS power consumption: 85mA/DC24V
- Installation: Standard 35mm Din Rail
- Signal interface: RS232/RS485  
HDL Buspro
- Dimension: 72x90x66(mm)
- Gateway between HDL Buspro and Ethernet

### Functions

- HDL Buspro and Ethernet double way data communication
- support internet remote access connection
- Intelligent data exchange, reducing data traffic

### Functions

- HDL Buspro and KNX two ways data converting
- Supports multiple types of data points
- Can be set up to 254 goals in two-way conversion control

SB-DN-232IP-Pro





## 4 / 8 Channel Dry Contact Sensor

MSD04.40 / MSD08.40

MSD04.40



### Parameters

- Power supply: DC12-30V
- BUS power consumption: 10mA/DC24V
- Installation: Screw fix installation
- Dimension: 45x45x16(mm)

### Functions

- 4 channels dry contact input
- 4 channels state indicator output
- Dimming function
- Tamper alarm
- Security function, to be used with the security module
- Switch type: Mechanical switch, Single-On, Single-Off, Single-On/Off, Combination-On, Combination-Off, Combinations, Multi-functional, Parallel switch
- Control target type: Scenes, sequences, universal switches, single channel adjustment, broadcast scene, broadcast channel, curtain control, panel control, GPRS function, fire alarm control and music play functions
- Support HDL Buspro online upgrading

MSD08.40



### Parameters

- Power supply: DC12-30V
- BUS power consumption: 10mA/DC24V
- Installation: Screw fix installation
- Dimension: 45x45x16(mm)

### Functions

- 8 channels dry contact input
- Dimming function
- Tamper alarm
- Security function, to be used with the security module
- Switch type: Mechanical switch, Single-On, Single-Off, Single-On/Off, Combination-On, Combination-Off, Combinations, Multi-functional, Parallel switch
- Control target type: Scenes, sequences, universal switches, single channel adjustment, broadcast scene, broadcast channel, curtain control, panel control, GPRS function, fire alarm control and music play functions
- Support HDL Buspro online upgrading

## 4 Channel Temperature Sensor

SB-MTS04.20

SB-MTS04.20



### Parameters

- Power supply: DC12-30V
- BUS power consumption: 9mA/DC24V
- Thermister operating temperature range: -30 °C ~ 100 °C
- Installation: Standard 86x86(mm) installation
- Dimension: 45x40x13(mm)

### Functions

- 4 channels temperature detection
- Each thermistor channel has 3 setting modes: By default, predetermined resistance, custom indexing table

## HDL Music Player

MZDN.432A

### Parameters

- Power supply: DC±24V
- Static power consumption: 1.6w
- Communication protocol: HDL Buspro, FTP,UDP
- Signal interface : RJ45, SD card, HDL Buspro, FM RCA Audio, Audio output
- Audio input voltage : 0.7vpp
- Input impedance : 50KΩ
- Output impedance : RL = 8 Ω、RR = 8 Ω
- Output power : 25W x 2
- Total Harmonic distortion : <0.05%
- Signal to Noise Ratio : 97dB
- Frequency response : 22Hz—20KHz
- Length of file name : ≤25 byte
- Music file format : Mp3
- Volume of SD Card : ≤ 32 G
- Dimensions : 180.2×90.03×64(mm)

MZDN.432A

NEW PRODUCT



HDL-MZDN.432 is a digital background music player. It has FM Radio, External input, FTP Audio stream, CD card. User can listen to the music from DLP panel and iPad, iPhone. This audio system supports songs from SD card, so it can be used for alarm system and voice service for home automation.

### Functions

- External input
- Internal SD card
- FM radio
- FTP Server
- Voice prompts

## 6 Ports Switch

HDL-MBR06.431

NEW PRODUCT

HDL-MBR06.431



### Parameters

- Working voltage: DC 12-30V
- Power consumption: 10mA/24VDC
- Ports: 6
- Devices for each port: 0-63
- Communication: HDL Buspro
- Housing material: Nylon, PC
- Installation: 35mm Din rail installation
- Dimension: 72x90x66(mm)

### Functions

- Filter data
- Check the data
- Supports 6 bus cables, each bus cable can connect up to 63 devices
- Communication: HDL Buspro
- Supports online upgrading

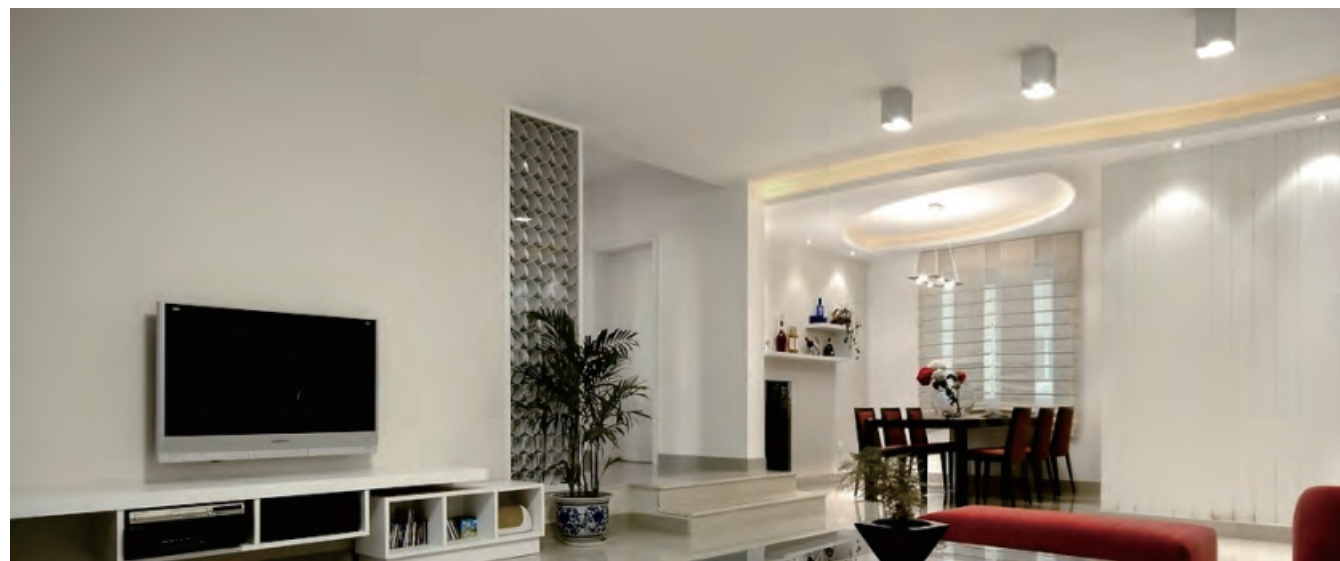

## Hotel Doorbell

MPB03.48

### Parameters

- Power supply : DC12-30V
- BUS power consumption : 25mA/DC24V
- Installation : Wall mounting
- Dimensions : 86×86×22.2(mm)

### Functions

- Visiting function, time setup
- Backlight brightness adjustable
- Do not disturb
- Support HDL Buspro upgrading
- Please clean

MPB03.48



### Keep improving

- Laser engraving
- Highlight the metal chrome material
- Working state display



MPH101.48 MPH102.48 MPH104.48 MPH108.48

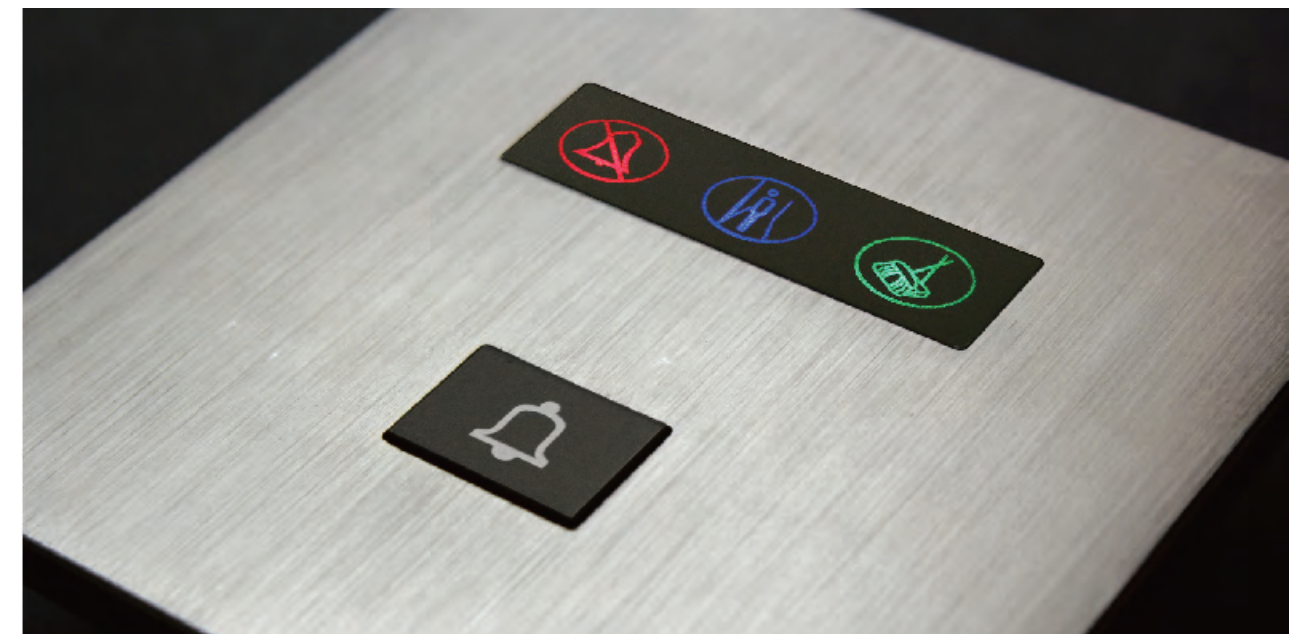



## Hotel Door Bell / Air Condition Switch

MPB01.48 / MPAC01.48

MPB01.48

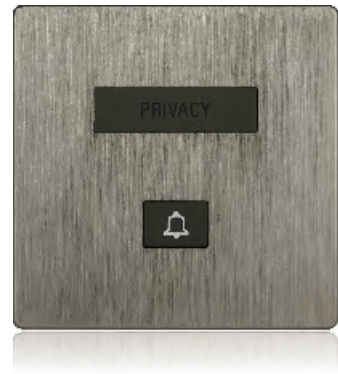

### Parameters

- Power supply : DC12-30V
- BUS power consumption : 24mA/DC24V
- Installation : Wall mounting
- Dimensions : 86×86×22.2 (mm)

### Functions

- PRIVACY status display;
- Visiting function ;
- Support HDL Buspro online upgrading

MPAC01.48



### Parameters

- Power supply : DC12-30V
- BUS power consumption : 25mA/DC24V
- Installation : Standard GI box
- Dimensions : 86×86×22.2(mm)

### Functions

- Control temperature, speed, mode, on/off
- Air conditioning mode: cooling, heating
- Speed: high, low, medium
- Display indoor temperature and air condition status etc
- Support HDL Buspro online upgrading

## Hotel Master Card Switch

MPC01.48 / MHIC.48

MPC01.48



### Parameters

- Power supply : DC12-30V
- BUS power consumption : 24mA/DC24V
- Card type : MIFARE ONE S50 13.56MHZ
- Installation : Wall mounting
- Dimensions : 86×86×32(mm)

### Functions

- Insert key for power
- Identification, insert a different card, run the corresponding scene card types: Guest card, service card, cleaner card, maintainer card, administrator card etc
- Can be set mechanical switch when plug the card, the switch can be set 1 to 49 targets.
- Other key mode can be set 1 to 99 targets
- Support HDL Buspro online upgrading

MHIC.48



### Parameters

- Power supply : DC12-30V
- BUS power consumption : 24mA/DC24V
- Card type : MIFARE ONE S50 13.56MHZ
- Installation : Standard GI and EU box
- Dimensions : 86×86×20.5(mm)

### Functions

- Working with MPPI.48 panel power interface
- Insert key for power
- Identification, insert a different card, run the corresponding scene
- Card types: guest card, servicing card, cleaner card, maintainer card, administrator card etc
- Can be set mechanical switch when Plug the card, the switch can be set 1 to 49 targets. other key mode can be set 1 to 99 targets
- Support HDL Buspro online upgrading

## Hotel Door Bell

SB-3S-Bell-XS / SB-3S-Bell

SB-3S-Bell-XS



### Parameters

- Power supply: DC15-30V
- Bus Power consumption: 45mA/DC24V
- Dimension: 105 x 170 x 40mm
- Installation: Back Box for HDL

### Functions

- Show different Number of Room, DND, Clean Room, and Laundry
- Door Bell • Open the Door by RF card & history record function
- Support HDL Buspro online upgrading

SB-3S-Bell



### Parameters

- Power supply: DC15-30V
- Bus Power consumption: 45mA/DC24V
- Dimension: 105 x 170 x 40mm
- Installation: Back Box for HDL

### Functions

- Show different Number of Room, DND, Clean Room, and Laundry
- Door Bell • Support HDL Buspro online upgrading

## Hotel Room Switch / Hotel Room Multimedia Panel

Classic Switch / Multi Media Connector

NEW PRODUCT

MPHAC01.48



SB-MS-Black



- Power Socket/ Telephone Outlet/ Data Outlet/S-VIDEO / AUDIO /VGA USB /HDMI

NEW PRODUCT

MPH201BN.48

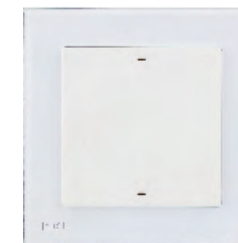

SB-MS-White



- Power Socket/ Telephone Outlet/ Data Outlet/S-VIDEO / AUDIO /VGA USB /HDMI

NEW PRODUCT

MPH202BN.48



SB-MS-Black-S



- Power Socket/ Telephone Outlet/ Data Outlet/S-VIDEO / AUDIO /VGA USB /HDMI

NEW PRODUCT

MPHS05.48



SB-MS-White-S



- Power Socket/ Telephone Outlet/ Data Outlet/S-VIDEO / AUDIO /VGA USB /HDMI



## Hotel IO Module / RCU Hotel Guest Room Control Unit

MHI0U.432 / MHRCU.433

## Hotel Room Control Host

SB-DN-48HNET

**Coming Soon**

NEW PRODUCT

MHI0U.432



### Parameters

- Power supply: DC15-30V
- BUS power consumption: 40mA/DC24V
- Dynamic power consumption: 90mA/DC24V
- Communication: HDL Buspro
- Buspro terminal: 0.75-0.85mm diameter single-core cable
- Dimension: 144×90×56.3 (mm)

### Functions

#### OUTPUTS:

- Channel 1 and 2 are dimming outputs, total current no more than 2A
- Channel 3 to 10 are switch outputs, each channel 5A
- Channel 11 and 12 are curtain switch control

#### INPUTS:

- 14-channel dry contact input
- 3-channel indoor doorbell control and 3-channel status indicator output
- 1-channel outdoor door bell control and 3-channel states indicator output
- 1-channel door bell switch control

MHRCU.433

NEW PRODUCT



### Parameters

- Power supply: DC20-30V
- Static power consumption: 60mA/DC24V
- Dynamic power consumption: 300mA/DC24V
- Signal interface: HDL Buspro, RJ45, INNER Buspro RJ45 interface: UDP/IP network interface
- STRIAC: 16A TRIAC, minimum load is 30w
- Buspro terminal: 0.75-0.85mm single-core cable
- Dimension: 216×90×56 (mm)

### Functions

#### The host control functions:

- 48 Channel control
- Total 99 scenes, each scene's running time is (0-250second)
- Can run the scene according to the status of card master
- Hotel host have RJ45 port for connectivity with another room and reception or manager center, with hotel manager software this module can integrate with third part property manager software

#### Mix control function:

- Channel NO.1~13 are Relay output, each channel 5A.
- Channel NO. 14-17, are relay output, each channel 10A
- NO. 18 - 21 channels for dimming, each channel 1A

#### Dry contract:

- 24 channels dry contract input

#### Door bell function:

- 5 channels state indicator output

#### LED output function

- 6channels normal switch state indicator output

SB-DN-48HNET



### Parameters

- Power supply: DC12-30V
- Bus Power Consumption: 40mA/DC24V
- Installation: Standard 35mm Din Rail
- Dimension: 72 x 90 x 66mm

### Functions

- 48 Channel control
- Total 99 scenes, each scene's running time is (0-250second)
- Switch function: HDL-Buspro and Ethernet exchange
- Receive the doorbell for touch control signals, control the doorbell status display
- Can identify Insert card module status and set scene and target
- Control the various states of A/C and upload the statue to the monitor software.
- Control the various states of curtain and upload the statue to the monitor software
- Receive various of panel's control signal, deal with channel and module's control
- High Scalability: add corresponding control component on the master control module when need expand new functions. And the system can work perfect with any exist systems. Such as: BA system, the central control system and security systems.

## Indoor Interphone

MTS10L.2WI



## Outdoor Interphone

MTOIL.2WI



## Card Holder With Three Service Buttons

MPTC03.46



## 4channels 3A LED Driver

MDLED0403.40



## 24CH Hotel Room Relay Module / 24 Zone Dry Contact Input Module

MHR2402.232 / SB-DN-DRY-24Z

## Hotel Guest Room MIX Controller

SB-DN-HMIX12 / SB-DN-HMIX20

MHR2402.232



Notes: To be used together with Hotel Room Control Host (SB-DN-48HNET)

SB-DN-DRY-24Z



SB-DN-HMIX12



SB-DN-HMIX20

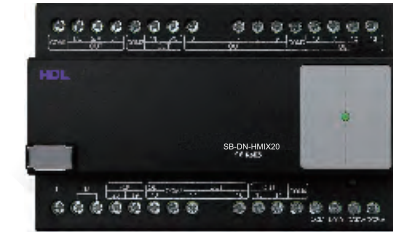

Notes: To be used together with Hotel Room Control Host (SB-DN-48HNET)  
6-13ch fluorescent lamp or LED light load less than 100W

### Parameters

- Power supply: DC24V
- BUS current: Dynamic current : 480mA  
Static current : 30mA
- Current in each channel: 2A
- Dimension: 144 x 90 x 66mm
- Installation: Standard 35 mm Din Rail

### Parameters

- Power supply: DC24V
- BUS power consumption: 12mA/DC24V
- Dimension: 144 x 90 x 66mm
- Installation: Standard 35 mm Din Rail

### Parameters

- Power supply: DC24V
- BUS power consumption: 200mA/DC24V
- Installation: Standard 35mm Din Rail
- Dimension: 144x90x66(mm)

### Parameters

- Power supply: DC24V
- BUS current: Dynamic current : 350mA  
Static current : 30mA
- Dimension: 144 x 90 x 66mm
- Installation: Standard 35 mm Din Rail

### Functions

- 24 channels relay output

### Functions

- 24 channels dry contact input
- Switch types include: Mechanical switches, Single-on, Single-Off, Single-On/Off, Combination on, Combination off, Combination On/Off, Invalid Switch, (Both mechanical switches and combination switches can set 49 control targets)
- Control target type: Scene, Sequence, Universal, Switch, Single Channel, Broadcast scene, Broadcast channel, curtain control, panel control, GPRS and so on.
- Security alerts feature need to be used together with Security Command Module

### Functions

- Channel No.10 and 11 are dimming outputs
- Max 12 areas, each area has 48 scenes
- Channel No. 1 to 8 are switch outputs, each channel 5A.
- Channel No.12 is DC0-10V control signal output for 0-10V fluorescent and LED light control
- Channel No.9 is curtain switch control
- Support HDL Buspro online upgrading

### Functions

- 1-3 channel, it control the low, medium and high levels for air-conditioning
- 4-5channel, it control the heating, refrigeration solenoid valve for air-conditioning
- 6-13 channel, it control the lamps (Current less than 1A)
- 14-15 channel, it control the lamps (Current less than 5A)
- 16-18 channel control the lamps for silicon control (Current less than 2A)
- 19-20 channel control the lamps for controllable silicon dimming (Current less than 2A)
- Relay lifetime : Up to 60000



## HDL Buspro System Program Software

SB-PW-Back

SB-PW-Back



### Description

- HDL Buspro Software is a flexible and powerful design tools, it is to be used for parameters setting for all HDL Busproducts

## HDL Buspro Graphic Monitor Software

GMS

GMS

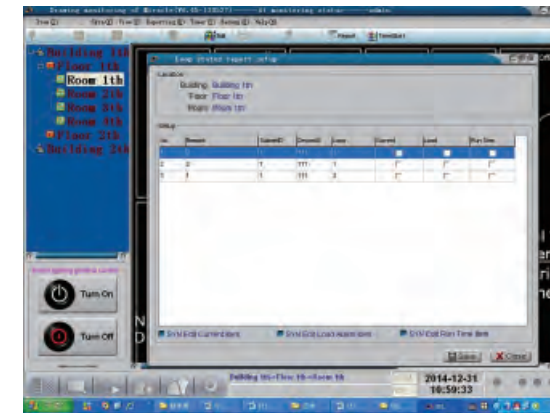

### Description

- HDL Buspro System Graphics Supervisory Control Software is the powerful and convenient graphical software. It graphically monitoring and control over the lighting circuit, it have run statistics with data, status for alarm, timer control, scene control, dimming controls, and hyperlink.
- Optional types: MSCS.100, MSCS.200, MSCS.500, MSCS.1500, MSCS.NL.
- Number of monitored objects: 100 controlled point, 200 controlled point, 500 controlled point, 1500 controlled point, and infinite controlled point.

## HDL Buspro Easy Setup Tool

MSSHOW.V1.0



### Description

- HDL Buspro Easy Setup tool is an easy functional design tool, which can program for all of HDL Buspro online or offline devices and meet all requirements of the systems engineering design. Meanwhile, it also supports the import and export of project data, enabling flexible data sharing.

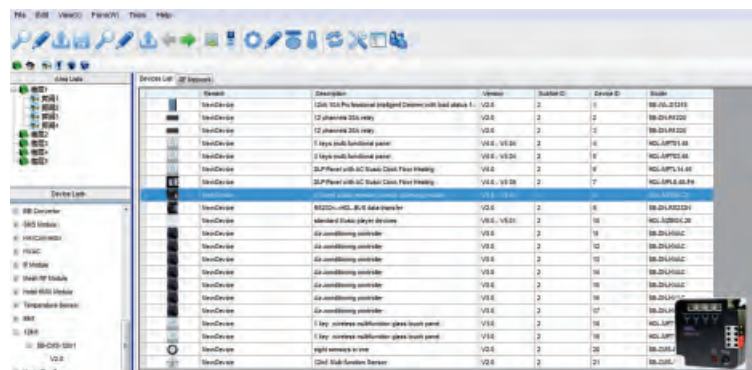

### Functions

- Easy for program and operate based on graphic icon.
- User-defined material, show the reality picture about the Hotel Room
- "SOS""Safety Box Protection" and many other functions, all lamps to centralized for management features
- Energy saving control function and Monitor for Air-conditioning
- Intelligent ID identify, more safety for customers, and reducing the energy consumption for hotel
- Date back up and restore function
- Curtain status for graphic display and control
- Dynamic fan graphic effects control

## Intelligent Hotel Room Management Software

IHMS.V1



### Description

- HDL Buspro Hotel Room Intelligent System Manage Software can be monitor to hotel room status and information, the database management, will safety and reliability. To management and control the hotel room entrances guard system, central air conditioning system, the intelligent light system, and the service system, room status will various intuitive ways of interacting dynamically to displayed, real-time to reflect room state, guest needs, services and equipment, assist in hotel room equipments, internal resource for real-time control of the integrated management and control system. The system uses modular design, has energy-saving, efficiency, and offers personalized service to customer, raising the level of hotel management and the hotel images.